

Complex Analysis

Lecture notes

Prof. Dr. Christoph Thiele*
Summer term 2016
Universität Bonn

June 7, 2016

Contents

1	Fundamentals	1
1.1	Quotients of holomorphic functions	43
1.2	The argument principle	50
1.3	The Riemann sphere	51
1.4	Möbius transforms	52
2	Riemann Mapping Theorem	53

1 Fundamentals

A complex number is a pair (x, y) of real numbers. The space $\mathbb{C} = \mathbb{R}^2$ of complex numbers is a two-dimensional \mathbb{R} -vector space. It is also a normed space with the norm defined as

$$|(x, y)| = \sqrt{x^2 + y^2}.$$

This is the usual Euclidean norm and induces the structure of a Hilbert space on \mathbb{C} . An additional feature that makes \mathbb{C} very special is that it also has a product structure defined as follows (that product is not to be confused with the scalar product of the Hilbert space).

*Notes by Joris Roos and Gennady Uraltsev.

Definition 1.1 (Product of complex numbers). For two complex numbers $(x_1, y_1), (x_2, y_2) \in \mathbb{C}$, their product is defined by

$$(x_1, y_1)(x_2, y_2) = (x_1x_2 - y_1y_2, x_1y_2 + y_1x_2).$$

This defines a map $\mathbb{C} \times \mathbb{C} \rightarrow \mathbb{C}$. It can be rewritten in terms of another product, the matrix product:

$$(x_1, y_1)(x_2, y_2) = (x_1, y_1) \begin{pmatrix} x_2 & y_2 \\ -y_2 & x_2 \end{pmatrix}.$$

In fact, we can embed the complex numbers into the space of real 2×2 matrices via the linear map

$$\begin{aligned} \mathbb{C} &\longrightarrow \mathbb{R}^{2 \times 2} \\ (x, y) &\longmapsto \begin{pmatrix} x & y \\ -y & x \end{pmatrix}. \end{aligned}$$

The map translates the product of complex numbers into the matrix product. This is very helpful to verify some of the following properties:

1. Commutativity (follows directly from the definition),
2. Associativity,
3. Distributivity,
4. Existence of a unit:

$$(x_1, y_1) = (1, 0)(x_1, y_1), \text{ and}$$

5. Existence of inverses: if $(x, y) \neq 0$, then

$$(x, y) \begin{pmatrix} x & y \\ -y & x \end{pmatrix} = \begin{pmatrix} x^2 + y^2 & xy - yx \\ x^2 + y^2 & x^2 + y^2 \end{pmatrix} = (1, 0).$$

In terms of the matrix representation this property is based on the fact that non-zero matrices of the form $\begin{pmatrix} x & y \\ -y & x \end{pmatrix}$ are always invertible:

$$\det \begin{pmatrix} x & y \\ -y & x \end{pmatrix} = x^2 + y^2 \neq 0 \tag{1.1}$$

for $(x, y) \neq 0$. It also entails that the inverse matrix is again of that form.

Summarizing, the product of complex numbers gives \mathbb{C} the structure of a field. The existence of such a product makes \mathbb{R}^2 unique among the higher dimensional Euclidean spaces \mathbb{R}^d , $d \geq 2$. Roughly speaking, the reason for this phenomenon is the very special structure of the above 2×2 matrices. In higher dimensions it becomes increasingly difficult to find a matrix representation such that Property 5 is satisfied. The only cases in which it is possible at all give rise to the quaternion ($d = 4$) and octonion ($d = 8$) product, neither of which is commutative (and the latter is not even associative).

Another important property is that we have compatibility of the product with the norm:

$$|(x_1, y_1)(x_2, y_2)| = |(x_1, y_1)| \cdot |(x_2, y_2)|.$$

This is a consequence of the determinant product theorem and the identity

$$|(x, y)| = \sqrt{\det \begin{pmatrix} x & y \\ -y & x \end{pmatrix}}.$$

One consequence of this is that for fixed (x_1, y_1) , the map $(x_1, y_1) \mapsto (x_1, y_1)(x_2, y_2)$ is continuous (but of course this can also be derived differently).

We now proceed to introduce the conventional notation for complex numbers.

Definition 1.2. We write $1 = (1, 0)$ to denote the multiplicative unit. $i = (0, 1)$ is called the *imaginary unit*. A complex number (x, y) is written as

$$z = x + iy.$$

$x =: \operatorname{Re}(z)$ is called the *real part* and $y =: \operatorname{Im}(z)$ the *imaginary part*. The *complex conjugate* of $z = x + iy$ is given by

$$\bar{z} = x - iy$$

We have the following identities:

$$\begin{aligned} i^2 &= (0, 1)(0, 1) = (-1, 0) = -1, \\ |z|^2 &= z\bar{z} = (x + iy)(x - iy) = x^2 + y^2, \\ \frac{1}{z} &= \frac{\bar{z}}{|z|^2}. \end{aligned}$$

The product of complex numbers has a geometric meaning. Observe that the unit circle in the plane consists of those complex numbers z with $|z| = 1$.

Say that z_1, z_2 lie on the unit circle. That is, $|z_1| = 1, |z_2| = 1$. Then also $|z_1 z_2| = |z_1| \cdot |z_2| = 1$, so also $z_1 z_2$ is on the unit circle. So the linear map $\mathbb{C} \rightarrow \mathbb{C}, z_1 \mapsto z_1 z_2$ maps the unit circle to itself. Recall that there are not too many linear maps with this property: only rotations and reflections. Since the determinant is positive by (1.1), it must be a rotation.

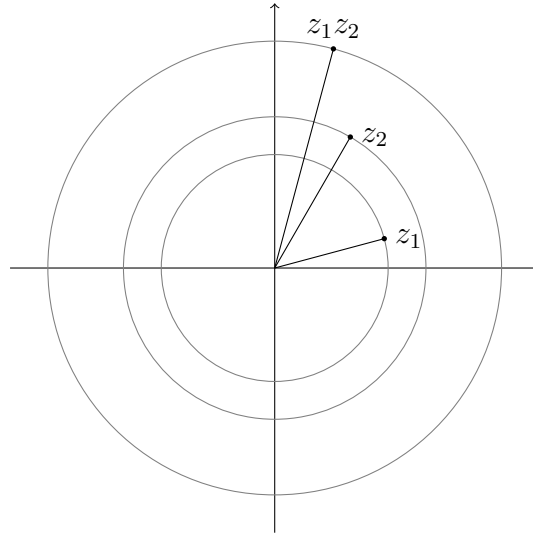

Every non-zero complex number can be written as the product of one on the circle and a real number:

$$z = \frac{z}{|z|} |z|$$

Multiplication with a real number corresponds to stretching, so we conclude from the above that multiplication with a complex number corresponds to a rotation and stretching of the plane.

Example 1.3. We use our recently gained geometric intuition to derive a curious formula for the square root of a complex number. Look at the following picture.

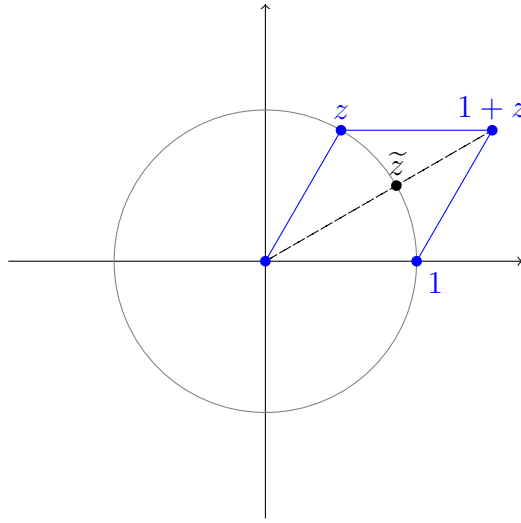

We have given some z with $|z| = 1$ and would like to find \tilde{z} with $\tilde{z}^2 = z$. The picture suggests to pick

$$\tilde{z} = \frac{1+z}{|1+z|}.$$

Indeed we have

$$\tilde{z}^2 = \frac{(1+z)^2}{(1+z)(1+\bar{z})} = \frac{1+z}{1+\bar{z}} = \frac{z\bar{z}+z}{1+\bar{z}} = z \frac{1+\bar{z}}{1+\bar{z}} = z.$$

Now let $z \neq 0$ be a general complex number and apply the above to $\frac{z}{|z|}$. Then the square roots of z are given by

$$\sqrt{z} = \pm \frac{1 + \frac{z}{|z|}}{\left|1 + \frac{z}{|z|}\right|} \sqrt{|z|}.$$

We now turn our attention to functions of a complex variable $f : \mathbb{C} \rightarrow \mathbb{C}$. A prime example is given by complex power series:

$$\sum_{n=0}^{\infty} a_n z^n = \lim_{N \rightarrow \infty} \sum_{n=0}^N a_n z^n.$$

To find out when this limit exists we check when the sequence of partial sums is Cauchy. Take $M < N$ and compute:

$$\left| \sum_{n=0}^N a_n z^n - \sum_{n=0}^M a_n z^n \right| = \left| \sum_{n=M+1}^N a_n z^n \right| \leq \sum_{n=M+1}^N |a_n z^n| = \sum_{n=M+1}^N |a_n| r^n,$$

where $r = |z|$. This implies that if $\sum_{n=0}^{\infty} |a_n| r^n$ converges in \mathbb{R} , then $\sum_{n=0}^{\infty} a_n z^n$ converges in \mathbb{C} . Next, $\sum_{n=0}^{\infty} |a_n| r^n < \infty$ holds if there exists $\tilde{r} > r$ with $\sup_n |a_n| \tilde{r}^n < \infty$ because

$$\sum_{n=0}^{\infty} |a_n| r^n = \sum_{n=0}^{\infty} |a_n| \tilde{r}^n \left(\frac{r}{\tilde{r}}\right)^n \leq \left(\sup_n |a_n| \tilde{r}^n\right) \sum_{n=0}^{\infty} \left(\frac{r}{\tilde{r}}\right)^n < \infty.$$

Definition 1.4. The *convergence radius* of a power series $\sum_{n=0}^{\infty} a_n z^n$ is defined as

$$R := \sup\{\tilde{r} : \sup_n |a_n| \tilde{r}^n < \infty\}.$$

- For $z \in D_R(0) = \{z : |z| < R\}$, the sum $\sum_{n=0}^{\infty} a_n z^n$ converges.
- For $|z| > R$, the sum $\sum_{n=0}^{\infty} a_n z^n$ diverges.
- For $|z| = R$ both convergence and divergence are possible.

Examples 1.5. The exponential series

$$e^z := \sum_{n=0}^{\infty} \frac{1}{n!} z^n.$$

has convergence radius $R = \infty$. The same holds for

$$\cos(z) := \sum_{n=0}^{\infty} \frac{(-1)^n}{(2n)!} z^{2n},$$

$$\sin(z) := \sum_{n=0}^{\infty} \frac{(-1)^n}{(2n+1)!} z^{2n+1}.$$

These combine to give the Euler formula,

$$e^{iz} = \cos(z) + i \sin(z).$$

From Analysis I we know¹ that

$$e^{z_1+z_2} = e^{z_1} e^{z_2}$$

for all $z_1, z_2 \in \mathbb{C}$.

¹Precisely speaking, we only proved it for real numbers, but the proof is literally the same.

These properties imply that for φ real, $e^{i\varphi}$ lies on the unit circle, in other words that $\sin(\varphi)^2 + \cos(\varphi)^2 = 1$:

$$\sin(\varphi)^2 + \cos(\varphi)^2 = |e^{i\varphi}|^2 = e^{i\varphi}\overline{e^{i\varphi}} = e^{i\varphi}e^{-i\varphi} = e^{i\varphi-i\varphi} = e^0 = 1.$$

Remark 1.6. General polynomials in x, y on \mathbb{R}^2 are of the form

$$\sum_{n,m=0}^N a_{n,m}x^n y^m = \sum_{n,m=0}^N a_{n,m} \left(\frac{z+\bar{z}}{2}\right)^n \left(\frac{z-\bar{z}}{2i}\right)^m = \sum_{n,m=0}^N b_{n,m}z^n \bar{z}^m.$$

In complex analysis we only consider the case $b_{n,m} = 0$ for $m \neq 0$.

Definition 1.7. Let $\Omega \subset \mathbb{C}$ be open. A function $f : \Omega \rightarrow \mathbb{C}$ is called *complex differentiable* at $z \in \Omega$ if there exists $\delta > 0$ such that $D_\delta(z) := \{w \in \mathbb{C} : |z-w| < \delta\} \subset \Omega$ and the function o , defined by the equation

$$f(z+h) = f(z) + hg(z) + o(h), \quad (1.2)$$

has the property that for all $\varepsilon > 0$ there exists $\delta > 0$ with $|o(h)| < \varepsilon|h|$ for all $|h| < \delta$.

Theorem 1.8. If $f(z) = \sum_{n=0}^{\infty} a_n z^n$ has convergence radius R , then

$$g(z) = \sum_{n=1}^{\infty} n a_n z^{n-1} = \sum_{n=0}^{\infty} (n+1) a_{n+1} z^n$$

also has convergence radius R and for $|z| < R$, f is complex differentiable at z .

Proof. We already know how to differentiate power series from real analysis. The proof of this theorem works exactly the same way as in the real case:

$$\begin{aligned} f(z+h) &= \sum_{n=0}^{\infty} a_n (z+h)^n = \sum_{n=0}^{\infty} \left(a_n z^n + n h z^{n-1} + \sum_{k=2}^n a_n \binom{n}{k} h^k z^{n-k} \right) \\ &= f(z) + hg(z) + o(h) \end{aligned}$$

and

$$\left| \frac{o(h)}{h} \right| \leq |h| \sum_{n=0}^{\infty} |a_n| n^2 \sum_{k=0}^{n-2} \binom{n-2}{k} |h|^k |z|^{n+2-k} \leq |h| \sum_{n=0}^{\infty} |a_n| n^2 (|z| + |h|)^{n+2}.$$

□

Compare this to the real Taylor series in \mathbb{R}^2 : let $f : \mathbb{R}^2 \rightarrow \mathbb{R}^2$ be totally differentiable in z , then there exists a matrix A with

$$f(z+h) = f(z) + Ah + o(h) \quad (1.3)$$

and for all $\varepsilon > 0$ there exists $\delta > 0$ such that $|o(h)| \leq \varepsilon|h|$ for $|h| < \delta$. Note that the product in (1.3) is the matrix product and the product in (1.2) is the product of complex numbers. They coincide if and only if

$$A = \begin{pmatrix} a & b \\ -b & a \end{pmatrix}.$$

Thus we find that a function $f(z) = (u(x, y), v(x, y))$ that is (real) totally differentiable at z is complex differentiable at z if and only if

$$\frac{\partial u}{\partial x}(z) = \frac{\partial v}{\partial y}(z) \quad \text{and} \quad \frac{\partial u}{\partial y}(z) = -\frac{\partial v}{\partial x}(z). \quad (1.4)$$

These are called the *Cauchy-Riemann differential equations*.

◇ ————— End of lecture 1. April 11, 2016 ————— ◇

We will now study some properties of functions on an open complex disk. In particular we will concentrate on the question of regularity and differentiability. In the previous lecture we have mentioned that power series are complex differentiable inside the disk of the radius of convergence. To establish notation let us introduce the following sets.

A We denote by A the set of all power series

$$A := \left\{ \sum_{n=0}^{\infty} a_n z^n : a_n \in \mathbb{C}, z \in D_R(0) \right\}$$

with radius of convergence at least $R > 0$ so that for all z in the domain $D_R(0) = \{z : |z - 0| < R\}$ the series converges absolutely (equivalently $\sup_n |a_n| \tau^n < \infty$ for any $0 \leq \tau < R$).

As noted previously, A is a subset of the set of all formal power series on $D_R \subset \mathbb{C}$ given by $\sum_{m,n=0}^{\infty} b_{n,m} x^n y^m$ with $x = \operatorname{Re}(z)$, $y = \operatorname{Im}(z)$. Equivalently these formal series can be expressed as $\sum_{n,m=0}^{\infty} a_{n,m} z^n \bar{z}^m$ and A puts both a on the growth of the coefficients $a_{n,m}$ given by the condition of being convergent on $D_R(0)$ and the additional constraint that $a_{n,m} = 0$ unless $m = 0$.

B We denote by B the set of functions that are complex differentiable in every point of the open disk $D_R(0)$. In particular, as per condition (1.2), B

consists of those functions $f : D_R(0) \mapsto \mathbb{C}$ such that for any point $z \in D_R(0)$ and for any increment $h : |z| + |h| < R$ there exists the complex derivative $g(z) \in \mathbb{C}$ i.e. a complex coefficient such that

$$f(z + h) = f(z) + hg(z) + o(h)$$

where $o(h)$ is some function (depending on z) for which for any $\epsilon > 0$ there exists a $\exists \delta > 0$ such that for any $|h| < \delta$, $|z| + |h| < R$ we have that $o|h| \leq \epsilon|h|$. Recall that this is related to total differentiability on $\mathbb{C} \equiv \mathbb{R}^2$. As a matter one can write the following for a totally differentiable function on \mathbb{C} :

$$f(z + h) = f(z) + A(z)h + o(h) \quad A(z) = \begin{pmatrix} a(z) & b(z) \\ c(z) & d(z) \end{pmatrix}.$$

Complex differentiability is equivalent to asking the differential as a linear map $A : \mathbb{R}^2 \mapsto \mathbb{R}^2$ can be represented by complex multiplication: $A(z)h = g(z)h$ for some $g(z) \in \mathbb{C}$. This holds if and only if $a(z) = d(z)$ and $b(z) = -c(z)$.

Let us recall the Cauchy-Riemann equations (1.4) and elaborate how they are related to complex differentiability. Setting $f(z) = (u(x, y), v(x, y))$, the equations are given by

$$\frac{\partial u(x, y)}{\partial x} = \frac{\partial v(x, y)}{\partial y} \quad \frac{\partial u(x, y)}{\partial y} = -\frac{\partial v(x, y)}{\partial x}.$$

We can rewrite this equation by defining the following two differential operators called $\frac{\partial}{\partial z}$ and $\frac{\partial}{\partial \bar{z}}$ by setting

$$\begin{aligned} \frac{\partial}{\partial z} &= \frac{1}{2} \left(\frac{\partial}{\partial x} + \frac{1}{i} \frac{\partial}{\partial y} \right) \\ \frac{\partial}{\partial \bar{z}} &= \frac{1}{2} \left(\frac{\partial}{\partial x} - \frac{1}{i} \frac{\partial}{\partial y} \right). \end{aligned}$$

Once again setting $f(x, y) = u(x, y) + iv(x, y)$ we can compute

$$\frac{\partial f}{\partial \bar{z}} = \frac{1}{2} \left(\frac{\partial u}{\partial x} - \frac{\partial v}{\partial y} + i \left(\frac{\partial v}{\partial x} + \frac{\partial u}{\partial y} \right) \right) = 0$$

It is apparent that the two Cauchy-Riemann equations are just the real and imaginary part of $\frac{\partial f}{\partial \bar{z}}$. Since we have already mentioned that complex differentiability is equivalent to a condition on the differential matrix A that corresponds to the Cauchy-Riemann equations in terms of partial derivatives,

it follows that a function is complex differentiable if and only if it is totally differentiable and has $\frac{\partial f}{\partial \bar{z}} = 0$. Furthermore, if f is complex differentiable then we write

$$f'(z) := \frac{\partial}{\partial z} f(z).$$

Finally, in terms of the the real and imaginary part separately we have

$$\frac{\partial}{\partial z} f(z) = \frac{1}{2} \left(\frac{\partial u}{\partial x} + \frac{\partial v}{\partial y} + i \left(\frac{\partial v}{\partial x} - \frac{\partial u}{\partial y} \right) \right).$$

C We denote by C the subset of continuous functions $f : D_R(0) \mapsto \mathbb{C}$ such that the following integral condition holds

$$\int_{(a,b,c)} f(z) dz = 0 \quad \forall a, b, c \in D_R(0).$$

Here (a, b, c) is the (oriented) boundary of the (oriented) triangle, also referred to as a simplex, formed by the points a , b , and c . We will identify (a, b, c) by the closed path composed of the three segments $a \rightarrow b \rightarrow c \rightarrow a$. The above integral is a special case of an integral along a path of a complex function. For now we restrict ourselves to the case were the support of the path is a complex segment, parametrized in linear fashion.

Definition 1.9 (Integral of a complex function along a segment). Consider the segment (a, b) with $a, b \in \mathbb{C}$ and a complex-valued continuous function $f : \Omega \subset \mathbb{C} \mapsto \mathbb{C}$ defined on an open neighborhood of (a, b) . We set the integral of the function f along (a, b) to be

$$\int_{(a,b)} f(z) dz := \int_0^1 f(bt + a(1-t)) (b-a) dt.$$

Here the integrand on the right hand side is a function $[0, 1] \mapsto \mathbb{C} \equiv \mathbb{R}^2$ and the integral is simply calculated coordinate-wise. Notice however that the integrand itself $f(bt + a(1-t)) \cdot (b-a)$ is expressed itself as a *complex* product.

This definition of the integral over a segment corresponds to the well known concept of a path integral, and extends it to complex functions:

$$\int_{(a,b)} f(z) dz = \int_0^1 f(bt + a(1-t)) (b-a) dt = \int_{\gamma} f d\gamma = \int_0^1 f(\gamma(t)) \gamma'(t) dt$$

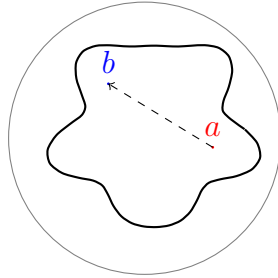

Figure 1: A segment defining a path from a to b .

with $\gamma(t) = bt + a(1-t)$ as the path that parameterizes the segment. We naturally extend this definition to the three oriented segments of the boundary of a triangle by setting

$$\int_{(a,b,c)} f(z)dz := \int_{(a,b)} f(z)dz + \int_{(b,c)} f(z)dz + \int_{(c,a)} f(z)dz.$$

Finally notice that the definition of integrating along a path is oriented and as such we have

$$\int_{(a,b)} f(z)dz = - \int_{(b,a)} f(z)dz.$$

This can be easily verified by a change of variables.

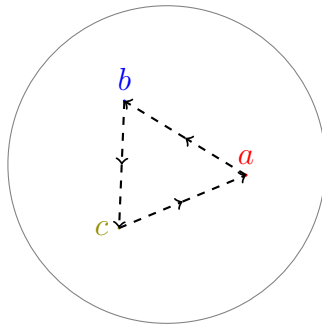

Figure 2: A triangle and its oriented boundary.

The characterization of the set C in terms of path integrals is geometric and does not rely on the smoothness of f . As a matter of fact we require f merely to be continuous. However we will now see that integral over triangles condition over all possible triangles implies stronger structure results and in particular that f is actually smooth and complex differentiable.

Theorem 1.10. *The classes of functions we introduced coincide i.e. $A = B = C$.*

A ⊂ B The rules of differentiation of power series imply immediately the inclusion $A \subset B$.

A ⊂ C We will now show directly that the path integral of a power series along a closed path, and specifically (a, b, c) is zero. In previous courses of analysis we have seen a similar statement for gradient fields and the proof followed from the existence of a primitive. We can, however, deduce the existence of a primitive of a power series formally and this will provide us with the needed elements to adapt a similar approach.

Recall the definition of the set A : $f \in A$ is of the form $f(z) = \sum_{n=0}^{\infty} a_n z^n$. Let us define its primitive via

$$F(z) := \sum_{n=0}^{\infty} \frac{1}{n+1} a_n z^{n+1}.$$

Clearly $F \in A$ since it is a power series and its radius of convergence is not smaller than that of f . This follows simply from the bound on the n^{th} coefficient of F by that of f :

$$\frac{1}{n+1} |a_n| \leq |a_n|.$$

We claim that F is effectively a primitive of f and in particular

$$\int_{(a,b)} f(z) dz = \int_0^1 f(a(1-t) + bt) (b-a) dt = F(b) - F(a).$$

The first equality is just the definition of a complex path integral. To show the second equality let us define $g(y) = F(\gamma(t))$ with $\gamma(t) = a(1-t) + bt$ and let us show that

$$g'(t) = f(a(1-t) + bt) (b-a).$$

This is essentially the chain rule for complex-valued complex differentiable functions. We write

$$\begin{aligned} g(t+h) &= F(\gamma(t+h)) = F(\gamma(t) + (b-a)h) \\ &= F(\gamma(t)) + (b-a)hf(\gamma(t)) + o((b-a)h) \\ &= g(t) + (b-a)hf(\gamma(t)) + o((b-a)h) \end{aligned}$$

Here we used that the complex differential of F in $\gamma(t)$ is given by $f(\gamma(t))$ and that $(b-a)h$ is a small complex increment. Notice also that h is a real increment. We have thus that

$$\int_0^1 f(a(1-t) + bt) (b-a) dt = F(b) - F(a)$$

and

$$\begin{aligned}\int_{(a,b,c)} f(z)dz &= \int_{(a,b)} f(z)dz + \int_{(b,c)} f(z)dz + \int_{(c,a)} f(z)dz \\ &= F(b) - F(a) + F(c) - F(b) + F(a) - F(c) = 0\end{aligned}$$

B \subset C This statement is known as “Theorem of Goursat”. Let $f \in B$ be complex differentiable in $D_R(0)$. We must show that for any $\tilde{r} < R$ and $\forall a, b, c \in \overline{D_{\tilde{r}}(0)}$ one has $\int_{(a,b,c)} f(z)dz = 0$. It is sufficient to show that for any $\epsilon > 0$ and $\forall a, b, c \in D_{\tilde{r}}(0)$ we have that

$$\left| \int_{(a,b,c)} f(z)dz \right| \leq \epsilon \max(|b-a|, |c-b|, |a-c|)^2.$$

The argument we present relies on an induction on scales. The term

$$\max(|b-a|, |c-b|, |a-c|)^2$$

on the right hand side of the above entry is a measure of the scale of “how large” or the *scale* of the triangle. We will show that the statement holds for triangles that have sufficiently small scale and then to an induction argument that will show that is the statement holds for a certain scale it also holds for triangle up to twice as large. This would allow us to conclude the statement for all triangles.

Part 1: We start by showing that the above bound holds for all points $a, b, c \in D_{\tilde{r}}(0)$ with $\max(|b-a|, |c-b|, |a-c|) < \delta_{min}$ for some $\delta_{min} > 0$. For any $z \in D_{\tilde{r}}(0)$ there exists $\delta = \delta(z)$ such that $\forall |h| < \delta$ we have

$$f(z+h) = f(z) + hf'(z) + o(h) \quad \text{with } |o(h)| < \frac{\epsilon}{8}|h|.$$

Reasoning by compactness we can find a finite set z_1, \dots, z_N such that $\overline{D_{\tilde{r}}(0)} \subset \bigcup_{j=1}^N D_{\delta(z_j)/3}(z_j)$ where $\delta(z_i)$ is the radius for which the above bound holds. Setting $\delta_{min} := \frac{\min_i \delta(z_i)}{3}$ one has that $\forall z \in \overline{D_{\tilde{r}}(0)} \forall |h| < \delta_{min}$ we have via the triangle inequality

$$f(z+h) = f(z) + hf'(z) + o(h) \quad \text{with } |o(h)| < \frac{\epsilon}{4}|h|.$$

Now consider two point a, b with $|b-a| < \delta_{min}$. We can evaluate the contribution of the three terms of the expansion of f to the line integral.

$$\int_{(a,b)} f(z)dz = \int_{(a,b)} f(z_0) + (z-z_0)f'(z_0) + o(z-z_0)dz$$

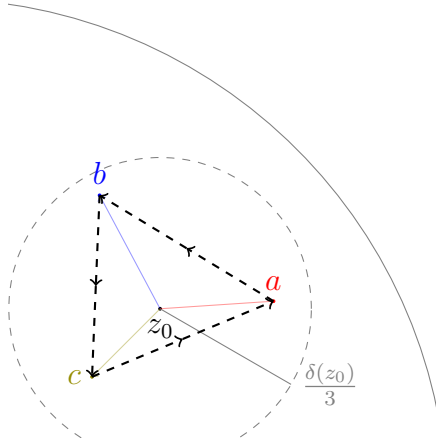

Figure 3: A triangle in a small circle

The first term gives

$$\int_0^1 f(z_0)(b-a)dt = f(z_0)(b-a).$$

The second term gives

$$\begin{aligned} & \int_0^1 f'(z_0)(bt - a(1-t) - z_0)(b-a)dt \\ &= f'(z_0) \left(\frac{1}{2}(b+a)(b-a) - a(b-a) - z_0(b-a) \right) \\ &= f'(z_0) \left(\frac{1}{2}(b^2 - a^2) + z_0(b-a) \right) \end{aligned}$$

We have crucially used complex differentiability of f here. As a matter of fact the algebraic manipulation relied on the commutativity of complex multiplication. If f were just any totally differentiable function then $f'(z_0)$ would be substituted by some arbitrary 2×2 matrix and the above identity would not necessarily hold.

Summing up the contributions of the three terms we obtain

$$\begin{aligned}
\int_{(a,b,c)} f(z)dz &= \int_{(a,b)} f(z)dz + \int_{(b,c)} f(z)dz + \int_{(c,a)} f(z)dz = \\
&= f(z_0)(b-a+c-b+a-c) \\
&+ f'(z_0) \left(\frac{1}{2}(b^2-a^2+c^2-b^2+a^2-c^2) + z_0(b-a+c-b+a-c) \right) \\
&+ \int_{(a,b,c)} o(z-z_0)dz
\end{aligned}$$

All terms except the last vanish while for the last we have the bound

$$\begin{aligned}
\left| \int_{(a,b,c)} f(z)dz \right| &= \left| \int_{(a,b,c)} o(z-z_0)dz \right| \\
&< \frac{\epsilon}{4} (|b-a| + |c-b| + |a-c|) \max_{z \in (a,b,c)} |z-z_0| \\
&< \frac{3\epsilon}{4} \max(|b-a|, |c-b|, |a-c|)^2
\end{aligned}$$

as required.

Part 2: We have now proved that the bound we seek holds for triangles that are small enough. In particular we require that $\max(|b-a|, |c-b|, |a-c|) < \delta_{min}$. We will now show an inductive procedure that shows that if the statement holds for when $\max(|b-a|, |c-b|, |a-c|) < \delta$ then the same is true if $\max(|b-a|, |c-b|, |a-c|) < 2\delta$.

The main idea is given by decomposing a triangle into smaller triangles in a uniform way.

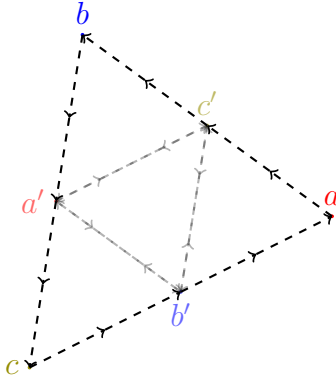

Figure 4: Decomposing triangles into smaller ones

To do so we use the median points as shown in figure 4. Let a', b', c' be the median points of the sides of (a, b, c) opposite of the respective vertices. We have

$$\begin{aligned} \int_{(a,b,c)} f(z)dz &= \int_{(a,c',b')} f(z)dz + \int_{(b,a',c')} f(z)dz + \int_{(c,b',a')} f(z)dz \\ &\quad + \int_{(a',b',c')} f(z)dz \\ \left| \int_{(a,b,c)} f(z)dz \right| &< \epsilon \left(\max(|c' - a|, |b' - c'|, |a - b'|)^2 + \max(\dots)^2 + \max(\dots)^2 \right. \\ &\quad \left. + \max(|b' - a'|, |c' - b'|, |a' - c'|)^2 \right) \\ &< 4\epsilon \frac{\max(|b - a|, |c - b|, |a - c|)^2}{4} \end{aligned}$$

as required. The crucial observation is that once we divide by the medians we obtain four triangles for which the largest of side lengths is bounded by a small $(1/2)$ factor of the lengths of the original triangle. This implies that first of all we may apply the assumptions at previous scale and that we obtain a bound with the same constant.

◇ ————— End of lecture 2. April 14, 2016 ————— ◇

We will prove the following stronger version of Goursat's theorem.

Theorem 1.11. *Let $z_0 \in D_R(0)$, $f : D_R(0) \rightarrow \mathbb{C}$ continuous and complex differentiable at all points of $D_R(0) \setminus \{z_0\}$. Then $f \in C$.*

Proof. It suffices to show that for all $\tilde{r} < R$, $a, b, c \in D_{\tilde{r}}(0)$ we have

$$\int_{(a,b,c)} f(z)dz = 0.$$

Let $10\delta = R - \tilde{r}$. By the same argument as in the proof of Goursat's theorem it suffices to show this for small triangles: for all $a, b, c \in \overline{D_{\tilde{r}}(0)}$ with $\max(|a - b|, |b - c|, |c - a|) \leq \delta/10$.

Case 1. $z_0 \notin D_{\delta/3}(a)$. Then $\int_{(a,b,c)} f(z)dz = 0$ holds by Goursat's theorem.

Case 2. $z_0 \in D_{\delta/3}(a)$. It suffices to show $\int_{(a,b,z_0)} f(z)dz = 0$ because

$$\int_{(a,b,c)} = \int_{(a,b,z_0)} + \int_{(b,c,z_0)} + \int_{(c,a,z_0)}.$$

We can also assume that the angle at z_0 is acute (if it is not acute, we bisect the angle at z_0 and consider the two resulting triangles). Next, construct a circle through z_0 that contains (a, b, z_0) . We can do this such that the radius is at most δ .

Let $\varepsilon > 0$ be arbitrary. We will show

$$\left| \int_{(a,b,z_0)} f(z) dz \right| \leq \varepsilon.$$

By continuity of f at z_0 we can choose points a' on (a, z_0) and b' on (b, z_0) such that $|f(z) - f(z_0)| < \varepsilon/(3\delta)$ for all z on the triangle (a', b', z_0) .

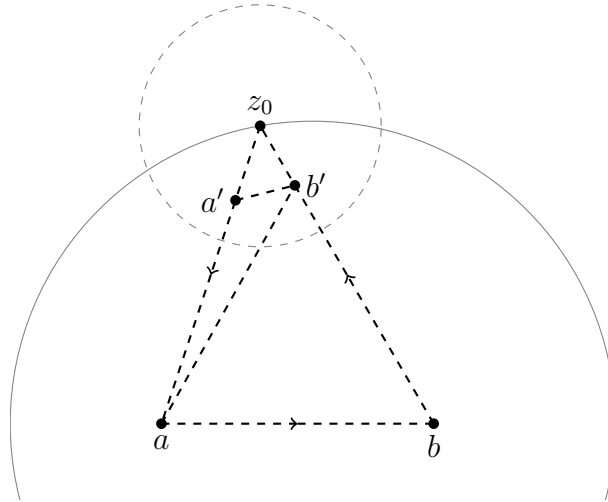

By Goursat's theorem we have

$$\int_{(a,b,b')} f(z) dz = \int_{(a',a,b')} f(z) dz = 0$$

so that

$$\int_{(a,b,z_0)} f(z) dz = \int_{(a',b',z_0)} f(z) dz.$$

We estimate,

$$\begin{aligned} \left| \int_{(a',b',z_0)} f(z) dz \right| &= \left| \int_{(a',b',z_0)} f(z) - f(z_0) dz \right| \\ &\leq \underbrace{\int_0^1 |f(bt + a'(1-t)) - f(z_0)| |b' - a'| dt + \dots}_{< \varepsilon} \end{aligned}$$

□

As a precursor to showing $B \subset A$ we first prove the following.

Theorem 1.12. *Let $f : D_R(0) \rightarrow \mathbb{C}$ complex differentiable on $D_R(0)$. Then for all $z_1 \in D_R(0)$ there exists $\delta > 0$ such that f can be represented by a convergent power series on $D_\delta(z_0) \subset D_R(0)$.*

Remark 1.13. In particular, this entails that functions which are complex differentiable in a neighborhood are automatically infinitely often complex differentiable.

This is a consequence of what is called *Cauchy's integral*.

Proof. For $w \in D_R(0)$ we consider the function

$$g_w(z) = \frac{f(z) - f(w)}{z - w}$$

with the understanding that $g_w(w) = f'(w)$. This function is continuous on $D_R(0)$ and complex differentiable on $D_R(0) \setminus \{w\}$. Continuity of g_w in w is a consequence of complex differentiability of f in w . Complex differentiability of g_w in $D_R(0) \setminus \{w\}$ follows by the product rule since $f(z) - f(w)$ and $\frac{1}{z-w}$ are both complex differentiable. Let us show the complex differentiability of $\frac{1}{z}$ on $\mathbb{C} \setminus \{0\}$ directly from the definition:

$$\frac{1}{z+h} - \frac{1}{z} = \frac{z - (z+h)}{z(z+h)} = \frac{-h}{z^2} + \frac{h}{z^2} - \frac{h}{z(z+h)} = -\frac{h}{z^2} + \frac{h^2}{z^2(z+h)} = \frac{-h}{z^2} + o(h)$$

where $o(h) = h^2/(z^2(z+h))$ so that

$$|o(h)| \leq |h^2| \left| \frac{1}{z^2(z+h)} \right| \leq |h|^2 \left| \frac{2}{z^3} \right|.$$

provided that $|h| < \frac{|z|}{2}$.

Choose $a, b, c \in D_R(0)$ such that z_0 lies in the interior of the triangle (a, b, c) . Further, pick $\delta > 0$ small enough so that the circle of radius 2δ around z_0 is contained in the interior of the triangle (a, b, c) .

Theorem 1.11 yields

$$\int_{(a,b,c)} g_w(z) dz = 0$$

for all $w \in D_\delta(z_0)$. That is,

$$\int_{(a,b,c)} \frac{f(z)}{z-w} dz = \left(\int_{(a,b,c)} \frac{dz}{z-w} \right) f(w)$$

Our claim is that

$$\int_{(a,b,c)} \frac{dz}{z-w} = \pm 2\pi i, \quad (1.5)$$

where the sign is according to whether the triangle (a, b, c) is oriented counter-clockwise (+) or clockwise (-). For the remainder of this proof, let us assume it is oriented counter-clockwise. We defer the proof of this claim to the end and first show how to use the equality

$$f(w) = \frac{1}{2\pi i} \int_{(a,b,c)} \frac{f(z)}{z-w} dz$$

to develop f into a convergent power series. The crucial point here is that on the right hand side, the free variable w no longer occurs inside the argument of f . Therefore we just need to know how to develop $w \mapsto \frac{1}{z-w}$ into a power series around z_0 :

$$\frac{1}{z-w} = \frac{1}{(z-z_0)(w-z_0)} = \frac{1}{z-z_0} \cdot \frac{1}{1-\frac{w-z_0}{z-z_0}} = \frac{1}{z-z_0} \sum_{n=0}^{\infty} \left(\frac{w-z_0}{z-z_0} \right)^n.$$

As a consequence,

$$\begin{aligned} \int_{(a,b,c)} \frac{f(z)}{z-w} dz &= \int_{(a,b,c)} \frac{1}{z-z_0} f(z) \sum_{n=0}^{\infty} \left(\frac{w-z_0}{z-z_0} \right)^n dz \\ &= \sum_{n=0}^{\infty} \left(\int_{(a,b,c)} \frac{f(z)}{(z-z_0)^{n+1}} dz \right) (w-z_0)^n dz, \end{aligned}$$

where the interchange of integration and summation is justified by uniform convergence of the power series since $2|w-z_0| < 2\delta < |z-z_0|$ by construction. It remains to prove (1.5). For starters we calculate

$$\int_{(a,b)} \frac{1}{z-w} dz = \int_0^1 \frac{b-a}{(b-a)t+a-w} dt = \int_0^1 \frac{1}{t+\frac{a-w}{b-a}} dt.$$

Temporarily denote $\frac{a-w}{b-a} = x + iy$ with x, y real numbers. Decompose the integral into real and imaginary part:

$$\int_0^1 \frac{1}{t+x+iy} dt = \int_0^1 \frac{(t+x)-iy}{(t+x)^2+y^2} dt = \int_0^1 \frac{t+x}{(t+x)^2+y^2} dt + i \int_0^1 \frac{-y}{(t+x)^2+y^2} dt.$$

Now we are only dealing with two real integrals that we can evaluate. The first equals

$$\frac{1}{2} \int_x^{x+1} \frac{2t}{t^2+y^2} dt = \frac{1}{2} (\log((x+1)^2+y^2) - \log(x^2+y^2)) = \log \frac{\sqrt{(x+1)^2+y^2}}{\sqrt{x^2+y^2}}. \quad (1.6)$$

The second equals

$$-\int_x^{x+1} \frac{y}{t^2 + y^2} dt = -\int_{x/y}^{(x+1)/y} \frac{1}{s^2 + 1} ds = -\arctan\left(\frac{x+1}{y}\right) + \arctan\left(\frac{x}{y}\right). \quad (1.7)$$

□

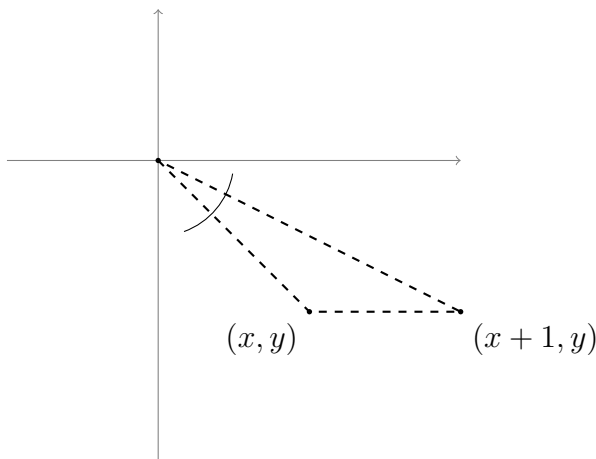

The angle at 0 in the triangle $(0, x + iy, x + 1 + iy)$ equals $\pm(1.7)$. Since addition and multiplication with complex numbers preserves angles, that angle equals the angle at w in the triangle (w, a, b) (the two triangles are similar).

For the same reason we have

$$\log \frac{|(x+1, y)|}{|(x, y)|} = \log \frac{|b-w|}{|a-w|}.$$

Applying the same reasoning to the other two segments (b, c) , (c, a) we get

$$\int_{(a,b,c)} \frac{1}{z-w} dz = \overbrace{\log \left(\frac{|b-w| |c-w| |a-w|}{|a-w| |b-w| |c-w|} \right)}{=0} + i(\varphi_1 + \varphi_2 + \varphi_3) = 2\pi i.$$

The last equality is by inspection of the figure:

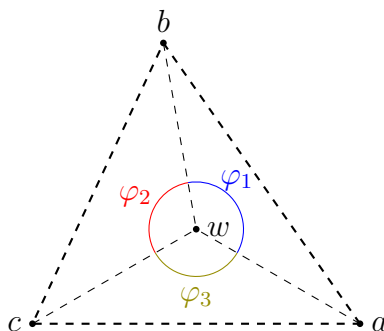

Let us recall the classes of complex-valued functions on the disk $D_R(0)$ that we have introduced so far.

$$\begin{aligned}
 A &:= \left\{ \sum_{n=0}^{\infty} a_n z^n : \text{the series converges absolutely on } D_R(0) \right\} \\
 B &:= \{ f : D_R(0) \mapsto \mathbb{C} : f \text{ is complex differentiable } \forall z \in D_R(0) \} \\
 C &:= \left\{ f : D_R(0) \mapsto \mathbb{C} : f \in C(D; \mathbb{C}), \int_{(a,b,c)} f(z) dz = 0 \forall a, b, c \in D_R(0) \right\}
 \end{aligned}$$

Additionally we have also introduced a new class \tilde{A} of functions that are locally power series:

$$\tilde{A} := \left\{ f : D_R(0) \mapsto \mathbb{C} : f(z_0 + h) = \sum_{n=0}^{\infty} a_n(z_0) h^n \forall z_0 \in D_R(0) |h| < \delta_{z_0} \right\}.$$

where the local power series converges representation converges absolutely for on a disk $D_{\delta_{z_0}}(z_0)$.

We have already seen $A \subset B$, $A \subset C$, $B \subset C$. We will now pass to showing the inclusion $C \subset B$ and we will then conclude that $B \subset A$. It has already been shown that $B \subset \tilde{A}$ via an improved Goursat's theorem.

Proposition 1.14 (Morera's Theorem: $C \subset B$). *Let $f : D_R(0) \mapsto \mathbb{C}$ be a continuous function such that for any three point $a, b, c \in D_R(0)$ one has*

$$\int_{(a,b,c)} f(z) dz = 0.$$

Set $F(z_1) := \int_{(0,z_1)} f(z) dz$ for any point $z_1 \in D_R(0)$. Then F is complex differentiable in any point z and

$$F(z_1 + h) = F(z_1) + \int_{(z_1, z_1+h)} f(z) dz$$

if $h \in \mathbb{C}$ is such that $z_1 + h \in D_R(0)$.

Proof. Clearly the contour integral condition applied to the triangle of the points $(0, z_1 + h, z_1)$ gives

$$\begin{aligned}
F(z_1 + h) &= \int_{(0, z_1+h)} f(z) dz \\
&= \int_{(0, z_1+h, z_1)} f(z) dz + \int_{(0, z_1)} f(z) dz + \int_{(z_1, z_1+h)} f(z) dz \\
&= F(z_1) + \int_{(z_1, z_1+h)} f(z) dz.
\end{aligned}$$

To obtain complex differentiability we estimate

$$\begin{aligned}
F(z_1 + h) &= F(z_1) + \overbrace{\int_{(z_1, z_1+h)} f(z_1) dz}^{f(z_1)h} + \int_{(z_1, z_1+h)} (f(z) - f(z_1)) dz \\
&= F(z_1) + f(z_1)h + \int_0^1 (f(z_1 + ht) - f(z_1)) h dt = F(z_1) + f(z_1)h + o(h)
\end{aligned}$$

with $o(h)$ such that for all $\epsilon > 0$ there exists a $\delta > 0$ such that $|o(h)| \leq \int_0^1 |f(z_1 + ht) - f(z_1)| |h| dt \leq \epsilon|h|$ if $|h| < \delta$. The last inequality follows from the continuity of f .

We already shown that $B \subset \tilde{A}$. Applying this to F shows that it is locally a power series. In the above expression we have shown that $f = F'$ and thus $f = F'$ formally as power series and it converges absolutely at least the same radius on which F converges and thus $f \in B$. \square

We now prove the inclusion $B \subset A$. To do so we need a “global” argument. The local argument gives $B \subset \tilde{A}$. We need to show that for any radius $R' < R$ (and in particular we will need to choose radii $R' < R'' < R''' < R$) the power series representing $f \in \tilde{A}$ in 0 actually converges on $D_{R'}(0)$.

Remark 1.15. Notice that the power series of $f \in \tilde{A}$ can be obtained in any given point (in this case in 0) using the Taylor expansion

$$\sum_{n=0}^{\infty} a_n z^n = \sum_{n=0}^{\infty} \frac{1}{n!} f^n(0) z^n.$$

The identity can be checked by deriving both sides n times and evaluating the expression in 0.

Figure 5: Discretization of an integral along a circle

For any fixed point $z_1 \in D_{R'}(0)$ the function $z \mapsto \frac{f(z)-f(z_1)}{z-z_1}$ is complex differentiable at any point $z \in D_{R'}(0) \setminus \{z_1\}$. This is strait-forward by applying the chain rule to the composition and product of continuous, complex-differentiable functions $f(z) - f(z_1)$ and $\frac{1}{z-z_1}$. Furthermore $z \mapsto f(z) - f(z_1)$ is complex differentiable in z_1 so

$$f(z) - f(z_1) = f'(z_1)(z - z_1) + o(z - z_1).$$

This implies that $\frac{f(z)-f(z_1)}{z-z_1}$ is continuous in z_1 and the value in z_1 is precisely $f'(z_1)$. Let us choose a sequence of 2^n points (a_1, \dots, a_{2^n}) on the circle $\{z \in \mathbb{C} : |z| = R'''\}$ going counterclockwise so that the segments (a_{i-1}, a_i) lie in $\overline{D_{R'''}(0)} \setminus D_{R''}(0)$. For example just set $a_j := R'''e^{i2\pi 2^{-n}j}$. Using the extension of Goursat's theorem 1.11 we know that all contour integrals of f over the triangles vanish (a_{i-1}, a_i, z_1) so we can write

$$0 = \sum_{i=1}^{2^n} \int_{(a_{i-1}, a_i, z_1)} \frac{f(z) - f(z_1)}{z - z_1} dz = \sum_{i=1}^{2^n} \int_{(a_{i-1}, a_i)} \frac{f(z) - f(z_1)}{z - z_1} dz$$

where the second equality holds because the radial segments of the integral cancel out. Thus we have

$$\begin{aligned} \sum_{i=1}^{2^n} \int_{(a_{i-1}, a_i)} \frac{f(z)}{z - z_1} dz &= \sum_{i=1}^{2^n} \int_{(a_{i-1}, a_i)} \frac{f(z_1)}{z - z_1} dz \\ &= f(z_1) \left(\sum_{i=1}^{2^n} \ln \frac{|a_i - z_1|}{|a_{i-1} - z_1|} + i(\phi_i - \phi_{i-1}) \right) \\ &= f(z_1) 2\pi i \end{aligned}$$

where ϕ_i is the argument of $a_i - z_1$. This follows from computations in (1.6) and (1.7). On the other have the above expression also equals to

$$\sum_{i=1}^{2^n} \int_{(a_{i-1}, a_i)} \frac{f(z)}{z} \sum_{m=0}^{\infty} \left(\frac{z_1}{z}\right)^m dz = \sum_{m=0}^{\infty} z_1^m \sum_{i=1}^{2^n} \int_{(a_{i-1}, a_i)} \frac{f(z)}{z^{m+1}} dz \quad (1.8)$$

This converges uniformly when $|z_1| < R'$ and $|z| > R''$. Notice that $f(z)$ for $z \in D_{R'''}(0)$ is uniformly bounded and $|z^{-m}| < (R''')^{-m}$ so for each integral we have the bound

$$\left| \int_{(a_{i-1}, a_i)} \frac{f(z)}{z^{m+1}} dz \right| \leq \|f \mathbf{1}_{D_{R'''}(0)}\|_{sup} (R''')^{-m-1} |a_i - a_{i-1}|.$$

Finally since via geometrical considerations we have that $\sum_{i=1}^{2^n} |a_i - a_{i-1}| \leq 2\pi R'''$ by we have that each coefficient satisfies the bound

$$\left| \sum_{i=1}^{2^n} \int_{(a_{i-1}, a_i)} \frac{f(z)}{z^m} dz \right| < 2\pi (R''')^{-m} \|f \mathbf{1}_{D_{R'''}(0)}\|_{sup}.$$

This implies that the series (1.8) has a convergence radius given at least by R''' .

Finally we remark a nice formula for the contour integral of $\frac{1}{z}$ over the unit circle $S^1 = \{z \in \mathbb{C} : |z| = 1\}$. Notice that the function $\frac{1}{z}$ does not fall into the class of functions we have defined complex contour integrals for. As a matter of fact $\frac{1}{z}$ is defined on the punctured disk $D_R(0) \setminus \{0\}$ for any $R > 0$ and is complex differentiable in any point where it is defined. However $\frac{1}{z}$ is not even continuous in $z = 0$ and as such none of the above theorems apply to it in the standard form. In particular we have seen that the integral over a triangle (a, b, c) containing 0 of $\frac{1}{z}$ is non-zero and equal to $2\pi i$ if it is counterclockwise (positive) oriented.

However we can define the path integral over a sufficiently smooth path $\gamma : [a, b] \mapsto \mathbb{C}$ by setting

$$\int_{\gamma} f(z) dz := \int_a^b f(\gamma(t)) \gamma'(t) dt.$$

Here we intend that that the parametrization of the circle is counterclockwise and is given by $\gamma : t \in [0, 2\pi) \mapsto e^{it} \in S^1$ so that

$$\int_{S^1} \frac{1}{z} dz = \int_0^{2\pi} \frac{1}{\gamma(t)} \gamma'(t) dt = \int_0^{2\pi} \frac{1}{e^{it}} i e^{it} dt = 2\pi i.$$

This discussion justifies spending some time on defining path integrals for complex functions and highlighting the important aspects of path integrals of complex differentiable functions specifically.

Definition 1.16 (Non self-intersecting curve C in \mathbb{C}). A non self-intersecting curve C in \mathbb{C} is the graph of an injective continuous path $\gamma : [a, b] \mapsto \mathbb{C}$.

Note that if C is a curve that is a graph of $\gamma : [a, b] \mapsto C \subset \mathbb{C}$ then γ is bijective $\gamma^{-1} : C \mapsto [a, b]$ is also continuous.

We can see this by reasoning by contradiction. Clearly the inverse $\gamma^{-1} : C \mapsto [a, b]$ is defined pointwise because of the injectivity of γ . Suppose that the inverse γ^{-1} is not continuous. That means that there exist two sequences of $(t_n), (\tilde{t}_n)$ such that

$$\liminf_{n \rightarrow \infty} |t_n - \tilde{t}_n| = \epsilon > 0 \quad \lim_{n \rightarrow \infty} |\gamma(t_n) - \gamma(\tilde{t}_n)| = 0.$$

Since the interval $[a, b]$ is compact we can restrict ourselves to a subsequence such that

$$\lim_{n \rightarrow \infty} t_n = t \in [a, b] \quad \lim_{n \rightarrow \infty} \tilde{t}_n = \tilde{t} \in [a, b] \quad \liminf_{n \rightarrow \infty} |t_n - \tilde{t}_n| > \epsilon.$$

Thus $|t - \tilde{t}| > \epsilon$ but by the continuity of γ we have that $\lim_{n \rightarrow \infty} \gamma(t_n) = \lim_{n \rightarrow \infty} \gamma(\tilde{t}_n) = \gamma(t) = \gamma(\tilde{t})$. This contradicts injectivity since $t \neq \tilde{t}$.

Suppose now that two paths $\gamma_1 : [a_1, b_1] \mapsto \mathbb{C}$ and $\gamma_2 : [a_2, b_2] \mapsto \mathbb{C}$ have the same image C and suppose that C is continuous and non self-intersecting. Then $\gamma_1^{-1}\gamma_2 : [a_2, b_2] \mapsto [a_1, b_1]$ is a continuous bijection with continuous inverse. The domain of this function and its image are real intervals, thus the function must be monotone and the image of $[a_2, b_2]$ must be $[a_1, b_1]$. We can thus define the direction of parameterization by asking that γ_1 and γ_2 parametrize C in the same direction if $\gamma_1(a_1) = \gamma_2(a_2)$ and $\gamma_1(b_1) = \gamma_2(b_2)$. We can identify a directed non self-intersecting graph $C \subset \mathbb{C}$ by the family of all paths that parametrize C in the same direction. This procedure induces a well defined order on C by imposing

$$\gamma(t_1) < \gamma(t_2) \iff t_1 < t_2.$$

Furthermore an ordering, together with the fact that C is in (ordered) bijection with a closed real interval shows that sup, inf exists of any subset of C and $\limsup \liminf$ of a sequence $z_n \in C$ is also well defined. Actually to be able to define these notions we do not need C the parametrization.

With such a notion of ordering we can define a non-intersecting curve C to be rectifiable if

$$\sup_{\substack{n, z_0 < \dots < z_n \\ z_0, \dots, z_n \in C}} \sum_{i=1}^n |z_i - z_{i-1}| < \infty.$$

Its arc-length parametrization is then given by introducing the function

$$\beta : C \mapsto [0, L] \quad \beta(z) = \sup_{\substack{n, z_0 < \dots < z_n < Z \\ z_0, \dots, z_n \in C}} \sum_{i=1}^n |z_i - z_{i-1}|.$$

We leave the following as an exercise

Exercise 1.17 (Arc Length Parametrization). β^{-1} is a parametrization of C by a segment $[0, L]$ and β^{-1} is 1-Lipschitz i.e. $|\beta^{-1}(t_2) - \beta^{-1}(t_1)| \leq |t_2 - t_1|$. We call L the length of the curve

For rectifiable curves the concept of path integrals is natural

Definition 1.18 (Path integral).

$$\int_C f(z)dz := \lim_{\epsilon \rightarrow 0} \sum_{\substack{a=z_0 < \dots < z_n=b \\ |z_i - z_{i-1}| < \epsilon}} f(z_i)(z_i - z_{i-1})$$

◇ ————— End of lecture 4. April 21, 2016 ————— ◇

Some additional comments regarding the path integral are in order. We also allow curves with self-intersections. Let $\Omega \subset \mathbb{C}$ be open and $\gamma : [a, b] \rightarrow \Omega$ Lipschitz, i.e. there exists $L < \infty$ such that for all $t_1, t_2 \in [a, b]$ we have

$$|\gamma(t_2) - \gamma(t_1)| \leq L|t_2 - t_1|.$$

We want to allow curves with self-intersections; thus we are not asking γ to be injective.

Our Lipschitz assumption has several consequences. The function $\operatorname{Re} \gamma$ is of bounded variation:

$$\sup_{a < t_0 < \dots < t_N < b} |\operatorname{Re} \gamma(t_n) - \operatorname{Re} \gamma(t_{n-1})| < L|b - a|$$

and similarly for $\operatorname{Im} \gamma$. Both $\operatorname{Re} \gamma$ and $\operatorname{Im} \gamma$ are also absolutely continuous, i.e. for all $\varepsilon > 0$ there exists $\delta > 0$ such that

$$\sum_{n=1}^N |\gamma(t_{2n}) - \gamma(t_{2n-1})| < \varepsilon \quad \text{if} \quad \sum_{n=1}^N |t_{2n} - t_{2n-1}| < \delta.$$

This implies differentiability almost everywhere with a derivative bounded in L^∞ . We also have

$$\int_a^x (\operatorname{Re} \gamma(t))' dt = \operatorname{Re} \gamma(x) - \operatorname{Re} \gamma(a).$$

The same holds for $\operatorname{Im} \gamma$.

Definition 1.19. For $f : \Omega \rightarrow \mathbb{C}$ continuous and $\gamma : [a, b] \rightarrow \Omega$ Lipschitz we define

$$\int_\gamma f(z)dz := \int_a^b f(\gamma(t))\gamma'(t)dt$$

Theorem 1.20. Let $\Omega \subset \mathbb{C}$ be open, $f : \Omega \rightarrow \mathbb{C}$ continuous and $\gamma : [a, b] \rightarrow \Omega$ Lipschitz. Then for all $\varepsilon > 0$ there exists $\delta > 0$ such that for all partitions $a = t_0 < \dots < t_N = b$ with $|t_n - t_{n-1}| < \delta$ we have

$$\left| \int_\gamma f(z)dz - \sum_{n=1}^N f(\gamma(t_n))(\gamma(t_n) - \gamma(t_{n-1})) \right| < \varepsilon.$$

Proof. We write

$$\begin{aligned}\int_{\gamma} f(z)dz &= \sum_{k=1}^N \int_{t_{k-1}}^{t_k} f(\gamma(t))\gamma'(t)dt \\ &= \sum_{n=1}^N \left(\int_{t_{n-1}}^{t_n} f(\gamma(t_n))\gamma'(t)dt + \int_{t_{n-1}}^{t_n} (f(\gamma(t)) - f(\gamma(t_n)))\gamma'(t)dt \right)\end{aligned}$$

The first term equals

$$\sum_{n=1}^N f(\gamma(t_n))(\gamma(t_n) - \gamma(t_{n-1}))$$

by the fundamental theorem of calculus for absolutely continuous functions. We can estimate the second term by exploiting uniform continuity of $f \circ \gamma$ on $[a, b]$. Namely, choose $\delta > 0$ small enough so that $|f(\gamma(t)) - f(\gamma(t'))| < \frac{\varepsilon}{L(b-a)}$ whenever $|t - t'| < \delta$. Here L is the Lipschitz constant of γ . Then we can estimate the error term as follows:

$$\left| \sum_{n=1}^N \int_{t_{n-1}}^{t_n} (f(\gamma(t)) - f(\gamma(t_n)))\gamma'(t)dt \right| < \sum_{n=1}^N (t_n - t_{n-1}) \frac{\varepsilon}{b-a} = \varepsilon.$$

□

The path integral is invariant under reparametrization. Assume that $s : [a, b] \rightarrow [\tilde{a}, \tilde{b}]$ is monotonously increasing, bijective and the new path

$$\tilde{\gamma} : [\tilde{a}, \tilde{b}] \rightarrow \mathbb{C}, \quad \gamma(t) = \tilde{\gamma}(s(t)) \text{ for all } t \in [a, b]$$

is Lipschitz. Then $\int_{\gamma} f(z)dz = \int_{\tilde{\gamma}} f(z)dz$. This can be shown by an appeal to the Riemann-Stieltjes sums from above (exercise).

Definition 1.21. Let $\Omega \subset \mathbb{C}$ be open. A function $f : \Omega \rightarrow \mathbb{C}$ is *holomorphic* in a point $z_0 \in \mathbb{C}$ if it is complex differentiable in a disc $D_R(z_0) \subset \Omega$.

The path integral leads to a simple way to exhibit (local) primitives of holomorphic functions. Let $\Omega = D_R(z_0)$ and f holomorphic, then there exists F with $F' = f$ and

$$\int_{\gamma} f(z)dz = F(\gamma(b)) - F(\gamma(a))$$

because $F \circ \gamma$ is Lipschitz.

$$(F \circ \gamma)'(t) = F'(\gamma(t))\gamma'(t).$$

The existence of a primitive depends on the topology of the domain (in fact it needs to be simply connected). For example, let $\Omega = \mathbb{C} \setminus \{0\}$. The function $f(z) = 1/z$ is holomorphic on Ω , but has no primitive on Ω .

We can exploit this property of holomorphic functions to define path integrals along curves $\gamma : [a, b] \rightarrow \Omega$ which are merely required to be continuous.

Definition 1.22. Let $f : \Omega \rightarrow \mathbb{C}$ be holomorphic and $\gamma : [a, b] \rightarrow \Omega$ continuous. We define the path integral $\int_{\gamma} f(z)dz$ as follows.

For all $t \in [a, b]$ we find δ_t and $\tilde{\delta}_t$ such that $D_{\delta_t}(\gamma(t)) \subset \Omega$ and for all \tilde{t} with $|\tilde{t} - t| < \tilde{\delta}_t$ we have that $\gamma(\tilde{t}) \in D_{\delta_t}(\gamma(t))$. Since $[a, b]$ is compact we can select finitely many t_n such that the intervals $(t_n - \frac{\tilde{\delta}_{t_n}}{3}, t_n + \frac{\tilde{\delta}_{t_n}}{3})$ cover $[a, b]$.

Let $\delta = \min_n \frac{\delta_{t_n}}{3}$. For all $t \in [a, b]$ there is an n such that for all $|\tilde{t} - t| < \delta$ we have $\gamma(\tilde{t}) \in D_{\delta_{t_n}}(\gamma(t_n))$. Find a partition $a = s_0 < \dots < s_N = b$ with $\max_n |s_n - s_{n-1}| < \delta$. Let F_n be a primitive of f on $D_{\delta_{t_n}}(\gamma(t_n))$. Now we can define

$$\int_{\gamma} f(z)dz := \sum_{n=1}^N F_n(\gamma(s_n)) - F_n(\gamma(s_{n-1})).$$

It remains to show that this definition is independent of the involved choices (exercise).

We turn our attention now to several very typical properties of holomorphic functions.

Theorem 1.23 (Mean value property). *Let f holomorphic on $D_R(z_0)$. Then for $r < R$ we have*

$$\frac{1}{2\pi} \int_0^{2\pi} f(z_0 + re^{it})dt = f(z_0).$$

Proof. Define

$$g(z) = \frac{f(z) - f(z_0)}{z - z_0}$$

with the understanding that $g(z_0) = f'(z_0)$. Then g is also holomorphic on $D_R(z_0)$. Let $\gamma : [0, 2\pi] \rightarrow D_R(z_0)$, $\gamma(t) = z_0 + re^{it}$. Then, $\int_{\gamma} g(z)dz = 0$. That is,

$$\int_{\gamma} \frac{f(z)}{z - z_0} dz = \int_{\gamma} \frac{f(z_0)}{z - z_0} dz = f(z_0) \int_0^{2\pi} \frac{1}{re^{it}} ire^{it} dt = 2\pi if(z_0).$$

On the other hand,

$$\int_{\gamma} \frac{f(z)}{z - z_0} dz = \int_0^{2\pi} \frac{f(z_0 + re^{it})}{re^{it}} ire^{it} dt = i \int_0^{2\pi} f(z_0 + re^{it}) dt.$$

The claim follows. □

Theorem 1.24 (Maximum principle). *Let $\Omega \subset \mathbb{C}$ be open and connected, f holomorphic on Ω . If $|f|$ assumes its maximum value at $z_0 \in \Omega$, then f is constant.*

In other words, non-constant holomorphic functions assume their maxima on the boundary of the domain of definition.

Proof. Let $f \not\equiv 0$. Define $g(z) = f(z) \frac{|f(z_0)|}{f(z_0)}$. Then $g(z_0) = |f(z_0)|$ and for all $z \in \Omega$,

$$\operatorname{Re} g(z) \leq g(z_0)$$

Consider $h(z) = g(z) - g(z_0)$. Then $\operatorname{Re} h(z) \leq 0$. Choose r with $\overline{D_r(z_0)} \subset \Omega$. By the mean value property,

$$0 = h(z_0) = \frac{1}{2\pi} \int_0^{2\pi} \operatorname{Re} h(z_0 + re^{it}) dt.$$

Since $\operatorname{Re} h$ is continuous and non-positive, we must have $\operatorname{Re} h(z_0 + re^{it}) = 0$ for all t . Also, $\operatorname{Re} h(z_0 + \tilde{r}e^{it}) = 0$ for all t , $\tilde{r} < r$. By the Cauchy-Riemann equations we obtain $\frac{\partial}{\partial x} \operatorname{Im} h = 0$ and $\frac{\partial}{\partial y} \operatorname{Im} h = 0$. Therefore h , and consequently also f , is constant in a neighborhood of z_0 . Thus we proved that the non-empty set $\{z \in \Omega : f(z) = f(z_0)\}$ is open. By continuity of f , it is also closed so it must equal Ω because Ω is connected. □

Definition 1.25 (Entire functions). A holomorphic function $f : \mathbb{C} \rightarrow \mathbb{C}$ is called *entire*.

Theorem 1.26 (Liouville). *Let f be an entire function. If f is bounded, then it is constant.*

Proof. Consider $g(z) = \frac{f(z) - f(z_0)}{z - z_0}$, $g(z_0) = f'(z_0)$ for an arbitrary $z_0 \in \mathbb{C}$. Then g is again entire and for all $\varepsilon > 0$ such that for all $|z - z_0| > 1/\varepsilon$ we have

$$|g(z)| \leq C\varepsilon.$$

By the maximum principle, $|g(z)| \leq C\varepsilon$ for all $z \in \overline{D_{1/\varepsilon}(z_0)}$. Since ε was arbitrary, $g \equiv 0$. □

Theorem 1.27. *Let f be entire and bijective with holomorphic inverse. Then there exist $a, b \in \mathbb{C}$ such that*

$$f(z) = az + b.$$

Proof. Let z_0 be such that $f'(z_0) \neq 0$ (exists because f cannot be constant). Without loss of generality suppose that $z_0 = 0$ (by translating the function). Also assume that $f(0) = 0$ (by subtracting $f(0)$ from f). Then the function $h(z) = f(z)/z$, $h(0) = f'(0)$ is entire and vanishes nowhere (since $f(z) \neq 0$ for $z \neq 0$ by injectivity). Thus also

$$g(z) = \frac{1}{h(z)}$$

is an entire function. We claim that it is also bounded. By continuity of f^{-1} , there is $\varepsilon > 0$ such that for all $|\xi| < \varepsilon$, $|f^{-1}(\xi)| \leq 1$. Thus, for $|z| > 1$, $|f(z)| \geq \varepsilon$, so $|g(z)| \leq \frac{1}{\varepsilon}$. For $|z| \leq 1$ we have boundedness by continuity. By Liouville's theorem, g is a constant and the claim follows. \square

Theorem 1.28. *Let $f : \Omega \rightarrow \mathbb{C}$ be holomorphic and non-constant. Assume $f(z_0) = 0$ for a given $z_0 \in \Omega$. Then there exists $\delta > 0$ with $f(z) \neq 0$ for all $z \in D_\delta(z_0) \setminus \{z_0\}$.*

This theorem shows that zeros of holomorphic functions are isolated.

Proof. Without loss of generality we assume $z_0 = 0$ (by translating the function). Write

$$f(z) = \sum_{n=N}^{\infty} a_n z^n = z^N \sum_{n=N}^{\infty} a_n z^{n-N}$$

with $a_N \neq 0$, $N \geq 1$. By continuity, there exists $\delta > 0$ such that $\sum_{n=N}^{\infty} a_n z^{n-N} \neq 0$ for all $z \in D_\delta(0)$. \square

Theorem 1.29. *Let $f : \Omega \rightarrow \mathbb{C}$ be holomorphic and non-constant. Then f is open (i.e. $f(\Omega) \subset \mathbb{C}$ is an open set).*

Proof. Let $w_0 \in f(\Omega)$. Then there is $z_0 \in \Omega$ such that $f(z_0) = w_0$. We argue by contradiction and suppose that w_0 is not in the interior of $f(\Omega)$. Thus, for every $\varepsilon > 0$ there exists $\xi \in D_\varepsilon(w_0)$ such that $\xi \notin f(\Omega)$. By the previous theorem we pick δ such that $f(z) - w_0 \neq 0$ for $z \in D_\delta(z_0) \setminus \{z_0\}$. Let $0 < r < \delta$. The set $K = \{z_0 + r e^{it} : t \in [0, 2\pi]\}$ is compact. Thus there exists $\varepsilon_0 > 0$ such that $|f(z) - w_0| > \varepsilon_0$ for all $z \in K$. Now take $\xi \in D_{\varepsilon_0/2}(w_0)$ such that $\xi \notin f(\Omega)$. Then the function

$$g(z) = \frac{1}{f(z) - \xi}$$

is holomorphic in Ω . For $z \in K$ we have

$$|g(z)| \leq \frac{1}{|f(z) - w_0| - |w_0 - \xi|} < \frac{1}{\varepsilon_0 - \varepsilon_0/2} = \frac{2}{\varepsilon_0}.$$

But,

$$|g(z_0)| = \frac{1}{|w_0 - \xi|} > \frac{2}{\varepsilon}.$$

This contradicts the maximum principle applied to g . □

◇ ————— End of lecture 5. April 25, 2016 ————— ◇

We have already seen in the previous lecture that holomorphic functions satisfy the maximum principle. Furthermore Liouville's principle states that an entire function that is bounded is actually constant. Notice that for this statement it is crucial that f be defined and be bounded on the whole \mathbb{C} and not simply on an open set Ω . Finally a similar theorem in spirit we have obtained the characterization of bijections of \mathbb{C} : Let $f : \mathbb{C} \rightarrow \mathbb{C}$ be a holomorphic function that is bijective. Then f is actually an affine function i.e. $\exists a, b \in \mathbb{C}$ such that

$$f(z) = az + b.$$

Once again such a structure theorem requires the domain of definition of f to be the whole complex plane \mathbb{C} .

We will continue to elaborate on some important structure properties of holomorphic functions however this time we will concentrate on more "local" properties i.e. results similar in spirit that however hold locally and do not require the domain of definition of f to be the whole complex plane. We have already shown the crucial fact that holomorphic functions are open mappings.

We thus pass to characterizing local invertibility properties of holomorphic functions.

Proposition 1.30. *Let $\Omega \subset \mathbb{C}$ an open domain and $f : \Omega \rightarrow \mathbb{C}$ be a holomorphic function. For any fixed point $z_0 \in \Omega$ the following are equivalent:*

1. $f'(z_0) \neq 0$;
2. there exists $\delta > 0$ such that $f \upharpoonright_{D_\delta(z_0)}$ is injective;
3. there exists $\delta > 0$ such that $f \upharpoonright_{D_\delta(z_0)}$ is bijective map with its image $\tilde{\Omega} \subset \mathbb{C}$ that is an open set and its inverse $g : \tilde{\Omega} \rightarrow D_\delta(z_0)$ is also holomorphic.

Proof.

(3) \Rightarrow (2) is straightforward.

(2) \Rightarrow (1) To show this let us suppose, without loss of generality, that $z_0 = 0 \in \Omega$ and $f(0) = 0$ (by translation and adding a constant). By assumption f is injective on $D_\delta(0)$ and let $K = f(\partial D_{\delta/2}(0))$. By injectivity $0 \notin K$. Furthermore K is compact since it is the image of a compact set $\partial D_{\delta/2}(0)$ via a continuous function, and thus there exists an $\epsilon > 0$ such that $D_{2\epsilon}(0) \cap K = \emptyset$.

Thus for all $z' \in D_\delta(0)$, for all $y \in D_\epsilon(0)$, and for all $z \in \partial D_{\delta/2}(0)$

$$\left| \frac{z' - z}{f(z) - y} \right| \leq c$$

for some $c < \infty$. This holds simply because

$$|z'| < \delta \quad |z| = \frac{\delta}{2} \quad |f(z) - y| \geq \epsilon.$$

Let us argue by contradiction and assume that $f'(0) = 0$. Notice that it is possible to choose z' arbitrarily close to 0 so that the following properties hold:

- $f(z') \in D_\epsilon(0)$ (using continuity of f);
- $f'(z') \neq 0$ since f' is holomorphic on $D_\delta(0)$ so its zeroes are discrete.

The function $z \mapsto f(z) - f(z')$ has a zero in z' and is holomorphic in $D_\delta(0)$ so it factorizes as

$$f(z) - f(z') = (z - z')g(z)$$

where $g(z)$ is holomorphic on the disk $D_\delta(0)$. Furthermore using the injectivity of f we have that $g(z)$ doesn't have any zeroes in $D_\delta(0)$ otherwise $f(z) = f(z')$ would have at least two solutions. So the inverse

$$\frac{z' - z}{f(z) - f(z')}$$

is also holomorphic in $D_\delta(0)$. Since the above function is holomorphic and bounded for $z \in \partial D_{\delta/2}(0)$ it is also bounded on the whole $D_\delta(0)$ by the constant c independently of the choice of z' .

But if $f'(0) = 0$ then expanding f in a power series on $D_\delta(0)$ we obtain

$$f(z) = \sum_{n=2}^{\infty} a_n z^n = z^2 \underbrace{\sum_{n=2}^{\infty} a_n z^{n-2}}_{\substack{\text{holomorphic in } D_\delta(0) \\ \text{bounded on } D_{\delta/2}(0)}}$$

so $|f(z)| < Cz^2$. Furthermore $|f(z')| < Cz'^2$ so setting $z = -z'$

$$\left| \frac{z' - z}{f(z) - f(z')} \right| > \frac{2|z'|}{C|z'|^2}.$$

Since long as z' can be chosen arbitrarily small this leads to a contradiction. **(1) \Rightarrow (3)**. There are several standard methods of proof of this implication. The possible approaches are as follows.

- Write down a formal power series for the inverse and show that the convergence radius is non-vanishing. Deduce from this that the inverse can be extended to an open set and then that f must have an open image: $\tilde{\Omega} = f(\Omega) = (f^{-1})^{-1}(\Omega)$.
- Use the implicit function theorem and explicitly compute the differential of the inverse map. Show that it is holomorphic and thus f^{-1} is holomorphic too.
- Uses the contour integral characterization of holomorphic functions.

We elaborate on the latter. First we show the local injectivity. Without loss of generality suppose $z_0 = 0$ and $f(z_0) = 0$ and let $f(z) = \sum_{n=1}^{\infty} a_n z^n$ with $a_1 \neq 0$ by assumption on the non-vanishing derivative. Suppose that $f(z_1) = f(z_2)$ for some $z_1 \neq z_2$ close to 0: $z_1, z_2 \in D_\delta(0)$ for some $\delta > 0$ small enough. This means that

$$a_1(z_1 - z_2) = \sum_{n=2}^{\infty} |a_n|(z_2^n - z_1^n) = (z_1 - z_2)g(z_1, z_2).$$

The function in two variables g satisfies

$$|g(z_1, z_2)| < \sum_{n=2}^{\infty} |a_n| n \delta^{n-1}$$

where $\delta = |z_1 - z_2|$ so

$$|a_1| \leq \sum_{n=2}^{\infty} |a_n| n \delta^{n-1}.$$

By continuity in δ this shows that δ cannot be to small and this means that injectivity cannot fail locally as required.

We now pass to proving that we are dealing with a bijections with an open set $\tilde{\Omega}$. Let $g : \tilde{\Omega} \rightarrow D_\delta(0)$ the point-wise inverse on $\tilde{\Omega} = f(D_\delta(0))$. The fact

that g is continuous follows from the fact that f is an open mapping. Thus the expression

$$\int_{\gamma} g(z) dz = 0$$

makes sense for Lipschitz curves γ . We thus want to show that for a closed curve $\gamma : [0, 1] \rightarrow \tilde{\Omega}$

$$\int_{\gamma} g(z) dz = 0$$

In particular there exists $\tilde{\gamma} : [0, 1] \rightarrow D_{\delta}(0)$ given by $\tilde{\gamma} = g \circ \gamma$ so that so that

$$\gamma = f \circ \tilde{\gamma}.$$

Obtaining the equality

$$\int_{\gamma} g(z) dz = \int_{\tilde{\gamma}} z f'(z) dz$$

would allow us to conclude since $\tilde{\gamma}$ is also closed and since $z f'(z)$ is holomorphic on a disk the right hand side vanishes. At a formal level, expanding the definition of a path integral yields

$$\int_0^1 g(\gamma(t)) \gamma'(t) dt = \int_0^1 g(f(\tilde{\gamma}(t))) f'(\tilde{\gamma}(t)) \tilde{\gamma}'(t) dt = \int_{\tilde{\gamma}} z f'(z) dz = 0.$$

The completion of the proof is left as an exercise. As a matter of fact one needs to show that $\tilde{\gamma}$ is Lipschitz. More generally we require $\tilde{\gamma}$ to be in some class of paths along which we can integrate continuous functions and apply the chain rule in the first equality when expanding $\gamma'(t) = (f \circ \tilde{\gamma})'(t)$.

A possible approach to giving a rigorous proof depends on showing that $\tilde{\gamma}$ is a Lipschitz curve since on every point of the support of γ the differential g' is well defined and bounded. This follows from the fact that on $D_{\delta}(0)$ f' is uniformly separated from zero. Notice that this does not require showing continuity of the derivative of the inverse of f but only that it is bounded and that simplifies the procedure from the first two approaches. Formally we require that $|g'| \in L^{\infty}$.

□

After this result on local inverses of holomorphic functions let us pass to questions of biholomorphisms (that is, bijective holomorphic maps) of the disk onto itself.

From now on we will denote the open unit disk in \mathbb{C} as $\mathbb{D} = D_1(0) \subset \mathbb{C}$. Let us now study bijection of the unit disk \mathbb{D} in itself. Up to multiplication by a scalar this classifies all the biholomorphisms between two disks. Notice that

$$f(z) = \lambda \frac{\omega - z}{1 - \bar{\omega}z} \quad f : \mathbb{D} \rightarrow \mathbb{D}$$

is a bijection and it is holomorphic as long as $|\lambda| = 1$ and $|\omega| < 1$. This follows from noticing that the above is a composition of two map

- complex rotation of angle $\arg \lambda$: $z \mapsto \lambda z$, $|\lambda| = 1$;
- $z \mapsto \frac{\omega - z}{1 - \bar{\omega}z}$, $|\omega| < 1$ that is well defined and holomorphic on \mathbb{D} since $1 - \bar{\omega}z \neq 0$ for $|z| < 1$.

Let us consider more in detail

$$g(z) = \frac{\omega - z}{1 - \bar{\omega}z}$$

that is holomorphic on \mathbb{D} and continuous on $\bar{\mathbb{D}}$. Notice that when $|z| = 1$ the function is given by

$$g(z) = \frac{\omega - z}{1 - \bar{\omega}z} = \frac{\omega - z}{z\bar{z} - \bar{\omega}z} = -\frac{1}{z} \frac{\omega - z}{\bar{\omega} - \bar{z}}$$

and clearly $|g(z)| = 1$ so by the maximal principle $|g(z)| < 1$ for all $z \in \mathbb{D}$. Furthermore a strait-forward computation gives the identity

$$g \circ g = Id.$$

Theorem 1.31 (Bijections of the unit disk). *Let $f : \mathbb{D} \rightarrow \mathbb{D}$ be a holomorphic bijective function. Then there exists a $|\lambda| = 1$ and $|\omega| < 1$ so that*

$$f(z) = \lambda \frac{\omega - z}{1 - \bar{\omega}z}. \quad (1.9)$$

First of all notice that if f is of the form (1.9) then $f(\omega) = 0$. In particular if $f : \mathbb{D} \rightarrow \mathbb{D}$ is a bijection then there exists a unique $\omega \in \mathbb{D}$ such that $f(\omega) = 0$ and also $f'(\omega) \neq 0$ by the characterization of local holomorphic bijections. Now as previously let

$$g(z) = \frac{\omega - z}{1 - \bar{\omega}z}$$

for the ω found above, This function also satisfies $g(\omega) = 0$ and $g'(\omega) \neq 0$. Thus we can conclude that both $\frac{f(z)}{g(z)}$ and $\frac{g(z)}{f(z)}$ are holomorphic functions (this

follows from explicitly writing down the quotient of the two power series representation of the functions). We would like to state that both

$$\left| \frac{f(z)}{g(z)} \right| \leq 1 \quad \left| \frac{g(z)}{f(z)} \right| \leq 1$$

to conclude using that

$$\left| \frac{g(z)}{f(z)} \right| = 1$$

and since the quotient is holomorphic $\frac{f(z)}{g(z)} = \lambda$ with λ a constant such that $|\lambda| = 1$.

We will obtain the two bounds above using a careful application of the maximum principle. We need to show that the above inequalities hold on the boundary $\partial\mathbb{D}$. Clearly $f(z) < 1$ on \mathbb{D} and $|g(z)| = 1$ on \mathbb{D} so by continuity

$$\left| \frac{f(z)}{g(z)} \right| \leq 1 \quad \text{on } \partial\mathbb{D}.$$

Now we need to prove the converse i.e. that in a sufficiently small neighborhood of the boundary $|f|$ is close to 1. But notice that $f^{-1}\left(\overline{D_{1-\epsilon}(0)}\right)$ is compact in \mathbb{D} since f^{-1} is well defined and continuous on \mathbb{D} . Thus

$$f^{-1}\left(\overline{D_{1-\epsilon}(0)}\right) \subset D_{1-\delta}(0)$$

so $|z| > 1 - \delta$ implies that $1 - \epsilon < |f(z)| < 1$. This concludes the reasoning. Finally as a corollary of what we have seen so far we can characterize the bijection of the punctured complex plane.

Theorem 1.32. *Let $f : \mathbb{C} \setminus \{0\} \rightarrow \mathbb{C} \setminus \{0\}$ be a holomorphic bijection. Then there exists an $a \in \mathbb{C} \setminus \{0\}$ such that*

$$f(z) = az \quad \text{or} \quad f(z) = \frac{a}{z}.$$

Proof. Let $y = f(1)$ then $\frac{1}{f(z)-y}$ is continuous and holomorphic as long as $|f(z) - y| > \epsilon$ i.e. when $|z - 1| > \delta$.

We see the above as a function of z and we use the fact that a bounded function on a punctured disk $D_\delta(0) \setminus \{0\}$ has a holomorphic extension to the whole $D_\delta(0)$. This is due to Cauchy's integral formula. Clearly if γ is a path along the boundary $\partial D_\delta(0)$ counterclockwise

$$z_0 \mapsto \frac{1}{2\pi i} \int_\gamma \frac{f(z)}{z - z_0} dz$$

defines a holomorphic function that coincides with f on $D_\delta(0)$ everywhere and is continuous across 0.

Let us distinguish two cases

Case 1: this is essentially the case when $f(z) \rightarrow \infty$ when $z \rightarrow 0$. Suppose that $\frac{1}{f(z)-y}$ vanishes in 0.

Case 2: $\frac{1}{f(z)-y}$ does not vanish in 0.

The conclusion of the proof is left as an exercise. □

Conclusion: Holomorphic bijections are very few.

◇ ————— End of lecture 6. April 28, 2016 ————— ◇

Definition 1.33. Two curves $\gamma_0, \gamma_1 : [a, b] \rightarrow \Omega$ with $\gamma_0(a) = \gamma_1(a)$, $\gamma_0(b) = \gamma_1(b)$ are called *homotopic in Ω* if there exists a continuous map $\gamma : [a, b] \times [0, 1] \rightarrow \Omega$ such that for all $t \in [a, b]$, $\gamma(t, 0) = \gamma_0(t)$, $\gamma(t, 1) = \gamma_1(t)$ and for all $s \in [0, 1]$, $\gamma(a, s) = \gamma_0(a)$ and $\gamma(b, s) = \gamma_0(b)$. Such a map γ is called a *homotopy*.

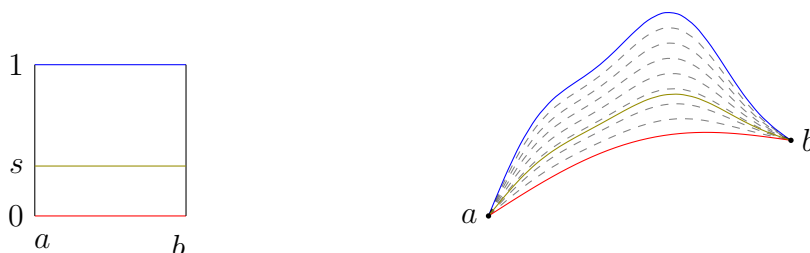

Theorem 1.34. Let f be holomorphic on Ω and γ_0, γ_1 homotopic in Ω . Then,

$$\int_{\gamma_0} f(z)dz = \int_{\gamma_1} f(z)dz.$$

Example 1.35. Consider $\Omega = \mathbb{C} \setminus \{0\}$ and $f(z) = 1/z$.

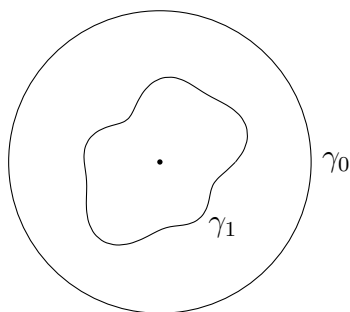

Proof of Theorem 1.34. Choose a homotopy γ and denote $\gamma_s = \gamma(\cdot, s)$. It suffices to show that for all $s \in [0, 1]$ there exists δ with

$$\int_{\gamma_{\tilde{s}}} f(z)dz = \int_{\gamma_s} f(z)dz$$

for all $|\tilde{s} - s| < \delta$. This is enough because we can define

$$s_0 = \inf \left\{ s : \int_{\gamma_s} f(z)dz \neq \int_{\gamma_0} f(z)dz \right\}$$

and apply the above to s_0 . The image of γ_{s_0} is compact. Therefore we find $\varepsilon > 0$ with $D_{10\varepsilon}(\gamma_{s_0}(t)) \subset \Omega$ for all $t \in [a, b]$. Since γ is uniformly continuous, there exists δ such that for $|s - s_0| < \delta$, $|t_1 - t_2| < \delta$ we have

$$|\gamma(t_1, s) - \gamma(t_2, s_0)| < \frac{\varepsilon}{2}.$$

Choose a partition $a = t_0 < t_1 < \dots < t_N = b$ with $|t_n - t_{n-1}| < \delta$.

Let $D_n = D_\varepsilon(t_n)$ and F_n primitive of f on D_n . Observe that

$$F_{n+1}(\gamma_s(t_{n+1})) - F_{n+1}(\gamma_{s_0}(t_{n+1})) = F_n(\gamma_s(t_{n+1})) - F_n(\gamma_{s_0}(t_{n+1})) \quad (1.10)$$

because $F_{n+1} = F_n + c$ on $D_{n+1} \cap D_n$.

$$\begin{aligned} \int_{\gamma_s} f(z)dz - \int_{\gamma_{s_0}} f(z)dz &= \sum_{n=0}^{N-1} F_n(\gamma_s(t_{n+1})) - F_n(\gamma_s(t_n)) \\ &\quad - \left(\sum_{n=0}^{N-1} F_n(\gamma_{s_0}(t_{n+1})) - F_n(\gamma_{s_0}(t_n)) \right) \\ &= \left(\sum_{n=0}^{N-1} F_n(\gamma_s(t_{n+1})) - F_n(\gamma_{s_0}(t_{n+1})) - F_{n+1}(\gamma_s(t_{n+1})) + F_{n+1}(\gamma_{s_0}(t_{n+1})) \right) \\ &\quad + F_N(\gamma_s(t_N)) - F_N(\gamma_{s_0}(t_N)) - F_0(\gamma_s(t_0)) + F_0(\gamma_{s_0}(t_0)) = 0, \end{aligned}$$

where the last equality is a consequence of (1.10) and $\gamma_s(b) = \gamma_{s_0}(b)$, $\gamma_s(a) = \gamma_{s_0}(a)$. \square

Definition 1.36. An open and closed set $\Omega \subset \mathbb{C}$ is called *simply connected* if every pair of continuous curves $\gamma_0, \gamma_1 : [a, b] \rightarrow \Omega$ with $\gamma_0(a) = \gamma_1(a)$, $\gamma_0(b) = \gamma_1(b)$ is homotopic in Ω .

Examples 1.37. • If Ω is convex, then it is simply connected. To see this we put $\gamma(t, s) = (1 - s)\gamma_0(t) + s\gamma_1(t) \in \Omega$ for γ_0, γ_1 as above and $s \in [0, 1], t \in [a, b]$.

- \mathbb{C} is simply connected.
- $\mathbb{C} \setminus (-\infty, 0]$ is simply connected. The function $z \mapsto z^2$ maps the right half plane to $\mathbb{C} \setminus (-\infty, 0]$.

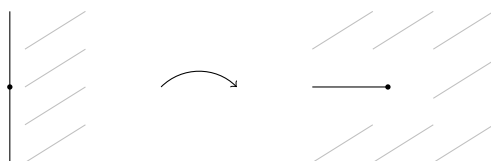

Theorem 1.38. Every holomorphic function f on a simply connected set Ω has a primitive in Ω .

Proof. Let $z_0 \in \Omega$. For every $z \in \Omega$ there exists a path $\gamma : [a, b] \rightarrow \Omega$ with $\gamma(a) = z_0, \gamma(b) = z$ (because Ω is connected). Note that if γ_0, γ_1 are two such paths, then they must be homotopic in Ω . Thus we can define

$$F(z) = \int_{\gamma} f(z)dz = \int_{\gamma_0} f(z)dz = \int_{\gamma_1} f(z)dz.$$

It remains to demonstrate that $F'(z) = f(z)$ for all $z \in \Omega$. Let $D_\varepsilon(z) \subset \Omega$, $h \in D_\varepsilon(z)$. Let F_ε be a primitive of f on $D_\varepsilon(z)$. Then

$$F(z_1) - F(z) = \int_{(z, z_1)} f(z)dz = F_\varepsilon(z_1) - F_\varepsilon(z) \quad \text{in } D_\varepsilon(z)$$

and therefore $F = F_\varepsilon + C$ on $D_\varepsilon(z)$, so $F' = F'_\varepsilon = f$. □

Definition 1.39. Let Ω be non-empty and simply connected and $\tilde{\Omega}$ open and connected. A holomorphic map $f : \Omega \rightarrow \tilde{\Omega}$ is called *universal cover* if

1. $f'(z) \neq 0$ for all $z \in \Omega$, and
2. for every continuous $\tilde{\gamma} : [a, b] \rightarrow \tilde{\Omega}$ and $z_0 \in \Omega$ with $f(z_0) = \tilde{\gamma}(a)$ there is a *lift* $\gamma : [a, b] \rightarrow \Omega$ with $\gamma(a) = z_0$ and $\tilde{\gamma}(t) = f(\gamma(t))$.

Lemma 1.40. The lifted path γ from the previous definition is uniquely determined.

Proof. Let $\gamma_0 \neq \gamma_1$ be two such curves. Consider

$$t_0 = \inf\{t : \gamma_0(t) \neq \gamma_1(t)\}.$$

By continuity of γ_0, γ_1 ,

$$\gamma_0(t_0) = \lim_{t \rightarrow t_0^-} \gamma_0(t) = \gamma_1(t_0) =: z_1$$

f is a local bijection, in particular on $D_\varepsilon(z_1)$ (exercise). \square

Lemma 1.41 (Homotopy lifting property). *For every homotopy $\tilde{\gamma} : [a, b] \times [0, 1] \rightarrow \tilde{\Omega}$ and lift $\gamma_0 : [a, b] \rightarrow \Omega$ of $\tilde{\gamma}(\cdot, 0)$ there exists a unique homotopy $\gamma : [a, b] \times [0, 1] \rightarrow \Omega$ with $f \circ \gamma = \tilde{\gamma}$ and $\gamma(\cdot, 0) = \gamma_0$.*

The proof is left as an exercise (use local bijectivity).

Exercise: f is surjective. It is not necessarily injective.

Theorem 1.42. *The map $f : \mathbb{C} \rightarrow \mathbb{C} \setminus \{0\}$, $f(z) = e^z$ is a universal cover.*

Remark 1.43. Then also $f : \mathbb{C} \rightarrow \mathbb{C} \setminus \{0\}$, $f(z) = e^{az+b}$ is universal cover (because $az + b$ is a biholomorphism $\mathbb{C} \rightarrow \mathbb{C}$). We will see that these are all the universal covers $\mathbb{C} \rightarrow \mathbb{C} \setminus \{0\}$. Roughly speaking, the exponential function is the unique universal cover $\mathbb{C} \rightarrow \mathbb{C} \setminus \{0\}$ up to biholomorphisms $\mathbb{C} \rightarrow \mathbb{C}$.

Proof. 1. $f'(z) = e^z \neq 0$ because $e^z e^{-z} = 1$ for all $z \in \mathbb{C}$.

2. Let $\tilde{\gamma} : [a, b] \rightarrow \mathbb{C} \setminus \{0\}$, $f(z_0) = \tilde{\gamma}(a)$.

Case 1: $\text{Im}(\tilde{\gamma}) \subset \mathbb{C} \setminus (-\infty, 0]$. Let F be a primitive of $\frac{1}{z}$ on $\mathbb{C} \setminus (-\infty, 0]$ (exists by Theorem 1.38). Then,

$$\left(\frac{e^{F(z)}}{z}\right)' = \frac{e^{F(z)} \frac{1}{z}}{z} - \frac{e^{F(z)}}{z^2} = 0$$

and therefore $\frac{e^{F(z)}}{z}$ is a constant. Define $\gamma(t) = F(\tilde{\gamma}(t)) - F(\tilde{\gamma}(a)) + z_0$.

Case 2: $\mathbb{C} \setminus [0, \infty)$ (image of $\mathbb{C} \setminus (-\infty, 0]$ under $z \mapsto -z$). Use the same argument as above.

General case: The image is in both these sets. Then we argue by contradiction. Let

$$t_0 = \inf\{t : \tilde{\gamma}|_{[a,t]} \text{ has no preimage } \gamma \text{ with } \gamma(a) = z_0\}.$$

Then $\tilde{\gamma}(t_0) \in \mathbb{C} \setminus (-\infty, 0]$ or $\tilde{\gamma}(t_0) \in \mathbb{C} \setminus [0, \infty)$. Use Case 1 or 2 to generate a preimage of $\tilde{\gamma}|_{[t_0-\delta, t_0+\delta]}$. Contradiction. \square

Example 1.44. The map $z \mapsto z^3$ mapping the right half-plane $\{z : \operatorname{Re} z > 0\}$ to $\mathbb{C} \setminus \{0\}$. We have $f' = 3z^2$ and f is surjective.

Example 1.45. The complex exponential function $z \mapsto e^z$ maps a horizontal strip $\{z \in \mathbb{C} : a < \operatorname{Im}(z) < b\}$ to a cone with aperture determined by a and b :

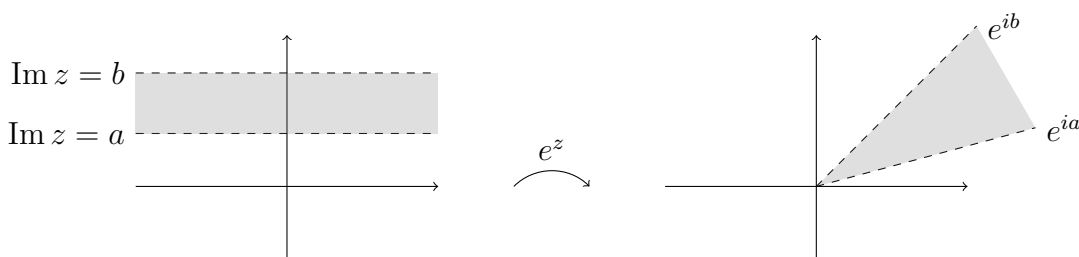

Theorem 1.46. Let $f : \Omega_1 \rightarrow \Omega_0$ be a universal cover, Ω_2 non-empty and simply connected and $g : \Omega_2 \rightarrow \Omega_0$ holomorphic. Then there exists a holomorphic map $h : \Omega_2 \rightarrow \Omega_1$ with $g = f \circ h$.

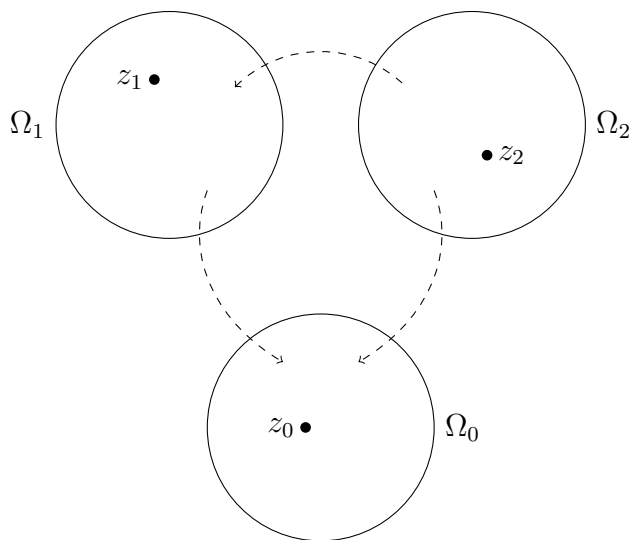

Proof. Choose $z_2 \in \Omega_2$ with $z_0 = g(z_2)$ and z_1 with $f(z_1) = z_0$ (possible because f is surjective). For $z \in \Omega_2$ choose a path $\gamma_2 : [a, b] \rightarrow \Omega_2$ with $\gamma_2(a) = z_2$ and $\gamma_2(b) = z$. Define $\gamma_0 = g \circ \gamma_2$. By the lifting property there exists a unique $\gamma_1 : [a, b] \rightarrow \Omega_1$ with $\gamma_1(a) = z_1$ and $f \circ \gamma_1 = \gamma_0$.

Define $h(z) = \gamma_1(b)$. This is independent of the choice of γ_2 (given z_1, z_0, z_2): every other $\tilde{\gamma}_2$ is homotopic to γ_2 since Ω_2 is simply connected. Then $\tilde{\gamma}_0$ is homotopic to γ_0 , $\tilde{\gamma}_1$ is homotopic to γ_1 . In particular, $\tilde{\gamma}_1(b) = \gamma_1(b)$. Also, h is holomorphic because it is a composition of holomorphic functions. \square

Remark 1.47. With z_2, z_1 given, h is uniquely determined. This follows by inspection of the proof.

Theorem 1.48. *Let $f_1 : \Omega_1 \rightarrow \Omega_0$ and $f_2 : \Omega_2 \rightarrow \Omega_0$ be universal covers. Then there exists a biholomorphism $h : \Omega_1 \rightarrow \Omega_2$ with $f_2 \circ h = f_1$.*

Proof. Applying the previous theorem we obtain g, h with $f_2 \circ h = f_1$ and $f_1 \circ g = f_2$. Then $f_1 \circ (g \circ h) = f_1$. Using the uniqueness in the previous theorem applied to f_1 and f_1 gives $g \circ h = \text{id}$. \square

Corollary 1.49. *Let $f : \mathbb{C} \rightarrow \mathbb{C} \setminus \{0\}$ be a universal cover. Then there exist $a, b \in \mathbb{C}$ such that $f(z) = e^{az+b}$.*

Proof. Apply the previous theorem to the universal cover $f(z) = e^z$ and recall that all the biholomorphic maps $\mathbb{C} \rightarrow \mathbb{C}$ are affine linear functions. \square

Corollary 1.50 (Existence of logarithms). *Let Ω be simply connected and $g : \Omega \rightarrow \mathbb{C} \setminus \{0\}$ holomorphic. Then there exists a holomorphic map $h : \Omega \rightarrow \mathbb{C}$ with $g(z) = e^{h(z)}$. Moreover, h is uniquely determined up to an additive constant of the form $2\pi in$ with $n \in \mathbb{Z}$.*

Corollary 1.51 (Existence of n th root). *If Ω is simply connected, $n \geq 2$ and $f : \Omega \rightarrow \mathbb{C} \setminus \{0\}$ holomorphic, then there exists a holomorphic function $g : \Omega \rightarrow \mathbb{C}$ with $f(z) = (g(z))^n$ for all $z \in \Omega$. Moreover, g is uniquely determined up to a multiplicative constant of the form $e^{\frac{2\pi ik}{n}}$ with $k \in \mathbb{Z}$.*

Proof. There exists h with $f(z) = e^{h(z)}$. Define $g(z) = e^{h(z)/n}$. \square

Remark 1.52. More generally, for arbitrary $\alpha \in \mathbb{C}$ we can also define $f^\alpha(z)$ on a simply connected Ω .

Definition 1.53. Let $\gamma_0 : [a, b] \rightarrow \mathbb{C} \setminus \{0\}$ be continuous with $\gamma_0(a) = \gamma_0(b)$. Pick a lifting $\gamma_1 : [a, b] \rightarrow \mathbb{C}$ with $e^{\gamma_1(t)} = \gamma_0(t)$ for all $t \in [a, b]$. We define the *winding number* of γ_0 around 0 by

$$n_{\gamma_0, 0} = \frac{1}{2\pi i} (\gamma_1(b) - \gamma_1(a)).$$

Note that this number is well-defined since the non-uniqueness caused by the additive constant in γ_1 is cancelled by taking the difference.

We have

$$e^{2\pi i n_{\gamma_0,0}} = e^{\gamma_1(b) - \gamma_1(a)} = e^0 = 1$$

and therefore $n_{\gamma_0,0} \in \mathbb{Z}$.

For γ_0 Lipschitz,

$$\begin{aligned} \frac{1}{2\pi i} \int_{\gamma_0} \frac{1}{z} dz &= \frac{1}{2\pi i} \int_a^b \frac{1}{\gamma_0(t)} \gamma_0'(t) dt = \frac{1}{2\pi i} \int_a^b \frac{1}{e^{\gamma_1(t)}} e^{\gamma_1(t)} \gamma_1'(t) dt \\ &= \frac{1}{2\pi i} (\gamma_1(b) - \gamma_1(a)) = n_{\gamma_0,0}. \end{aligned}$$

1.1 Quotients of holomorphic functions

Considering $\mathbb{C} \cup \{\infty\}$ we adopt the conventions that $\frac{1}{0} = \infty$ and $\frac{1}{\infty} = 0$.

Definition 1.54. Let Ω be open. A function $f : \Omega \rightarrow \mathbb{C} \cup \{\infty\}$ is called *meromorphic in the point* $z \in \Omega$ if there exists $\delta > 0$ such that either f or $\frac{1}{f}$ is holomorphic on $D_\delta(z)$. f is called *meromorphic on* Ω if it is meromorphic in every point $z \in \Omega$.

Remarks 1.55. • If f is holomorphic in z , then f is meromorphic in z .

- f is meromorphic in z if and only if $\frac{1}{f}$ is meromorphic in z .
- If f is non-constant and meromorphic in z then there exists $\delta > 0$ such that f maps $D_\delta(z) \setminus \{z\}$ to $\mathbb{C} \setminus \{0\}$ and $f \upharpoonright_{D_\delta(z) \setminus \{z\}}$ is holomorphic.

Proof. Case 1: $f(z) \in \mathbb{C} \setminus \{0\}$. By continuity we can choose $\delta > 0$ such that both $f \upharpoonright_{D_\delta(z) \setminus \{z\}}$ and $\frac{1}{f} \upharpoonright_{D_\delta(z) \setminus \{z\}}$ are holomorphic.

Case 2: $f(z) = 0$. The claim follows by the theorem on isolated zeros.

Case 3: $f(z) = \infty$. Then z is an isolated zero of $\frac{1}{f}$. □

◇ ————— End of lecture 8. May 9, 2016 ————— ◇

Proposition 1.56. Let $\Omega \subset \mathbb{C}$ be an open connected domain and let $f : \Omega \rightarrow \mathbb{C} \cup \{\infty\}$ be a function. Given a point $z \in \Omega$ the following are equivalent:

1. f is meromorphic in z ;
2. there exists $\delta > 0$, $N \in \mathbb{Z}$, and $g : \mathbb{D}_\delta(z) \rightarrow \mathbb{C}$ a holomorphic function such that

$$f(\tilde{z}) = (\tilde{z} - z)^N g(\tilde{z}) \quad \text{for all } \tilde{z} \in \mathbb{D}_\delta(z) \setminus \{z\},$$

or otherwise $f \equiv \infty$ or $f \equiv 0$;

3. there exists $\delta > 0$ and $N \in \mathbb{Z}, N \geq 0$ and a_{-1}, \dots, a_{-N} and a unique holomorphic function $g: \mathbb{D}_\delta(z) \rightarrow \mathbb{C}$ such that

$$f(\tilde{z}) = \underbrace{\sum_{n=1}^N a_{-n}(\tilde{z} - z)^{-n}}_{\text{Principle part}} + g(\tilde{z}) \quad \text{for all } \tilde{z} \in \mathbb{D}_\delta(z) \setminus \{z\} \quad (1.11)$$

, or otherwise $f \equiv \infty$;

4. there exists $\delta > 0$ such that $f \upharpoonright_{\mathbb{D}_\delta(z) \setminus \{z\}}$ is holomorphic and the image $f(\mathbb{D}_\delta(z))$ is not dense in \mathbb{C} , or otherwise $f \equiv \infty$.

Proof. **1) \implies 2)**

Suppose that we are in the case that the function f is holomorphic in $\mathbb{D}_{\delta_1}(z)$.

- If f is non-vanishing in z , then there exists $\delta_1 > \delta > 0$ such $f \neq 0$ on $\mathbb{D}_\delta(z)$. Then function $g := f \upharpoonright_{\mathbb{D}_\delta(z)}$ is holomorphic and we take $N = 0$.
- If $f(z) = 0$ and $f \not\equiv 0$ then the zeroes of f are discrete and thus there exists $0 < \delta < \delta_1$ such that $f \upharpoonright_{\mathbb{D}_\delta(z) \setminus \{z\}}$ is non-vanishing. Furthermore f admits a series expansion around z of the form $f = \sum_{n=0}^{\infty} b_n(\tilde{z} - z)^n$. Let $N = \min \{n: b_n \neq 0\}$ and set $g(\tilde{z}) = \sum_{n=0}^{\infty} b_{n+N}(\tilde{z} - z)^n$. The results follows.

Suppose now that we are in the case when $\frac{1}{f}$ is holomorphic in $\mathbb{D}_{\delta_1}(z)$. Similarly as before we can write

$$\frac{1}{f(\tilde{z})} = (\tilde{z} - z)^N g(\tilde{z})$$

for $\tilde{z} \in \mathbb{D}_\delta(z)$ for some $0 < \delta < \delta_1$ where $g(\tilde{z})$ is a non-vanishing holomorphic function on $\mathbb{D}_\delta(z)$. Thus we have that

$$f(\tilde{z}) = (\tilde{z} - z)^{-N} \frac{1}{g(\tilde{z})}.$$

holds on $\mathbb{D}_\delta(z)$ and this concludes the proof of this part of the equivalence **2) \implies 3)**

Suppose that $f(\tilde{z}) = (z - \tilde{z})^N g(\tilde{z})$ in $\mathbb{D}_\delta \setminus \{z\}$ where $g(\tilde{z})$ is a holomorphic function on $\mathbb{D}_\delta(z)$. If $N \geq 0$ the principle part vanishes and 3) holds trivially. In the case that $N < 0$ one has

$$g(\tilde{z}) = \sum_{n=0}^{\infty} a_n(\tilde{z} - z)^n \quad f(\tilde{z}) = \sum_{n=0}^{\infty} a_n(\tilde{z} - z)^{n-N} = \sum_{n=-N}^{+\infty} a_{n+N}(\tilde{z} - z)^n.$$

The sum over the terms $N \leq n < 0$ yields the principle part while

$$\sum_{n=0}^{+\infty} a_{n+N}(\tilde{z} - z)^n$$

defines a holomorphic function around z with the same radius of convergence as g .

3) \implies **4)** In the case that $N = 0$, there is no principle part so the function $g|_{\overline{\mathbb{D}_{\delta/2}}}$ is continuous on a compact set so it is bounded. As such it has a bounded, not dense, image. The same applies to the case when $N > 0$. Suppose that $N < 0$ and, without loss of generality we can assume $a_N \neq 0$ so that

$$\left| \sum_{n=1}^{N-1} a_{-n}(\tilde{z} - z)^{-n} \right| \leq \frac{1}{3} |a_{-N}(\tilde{z} - z)^{-N}|$$

for $|\tilde{z} - z|$ small enough. Similarly for $|\tilde{z} - z|$ small enough one also has

$$|g(\tilde{z})| \leq \frac{1}{3} |a_{-N}(\tilde{z} - z)^{-N}|$$

thus

$$\begin{aligned} |f(\tilde{z})| &\geq |a_{-N}(\tilde{z} - z)^{-N}| - |g(\tilde{z})| - \left| \sum_{n=1}^{N-1} a_{-n}(\tilde{z} - z)^{-n} \right| \\ &\geq \frac{1}{3} |a_{-N}(\tilde{z} - z)^{-N}| \geq \frac{|a_{-N}|}{3} \delta^{-N} \end{aligned}$$

for \tilde{z} in the disk $\mathbb{D}_\delta(z)$. Thus the image of this disk cannot be dense.

4) \implies **1)**

Suppose that the image $f(\mathbb{D}_\delta(z))$ is not dense in \mathbb{C} . This means there exists a disk $\mathbb{D}_\epsilon(y)$ disjoint from the image $f(\mathbb{D}_\delta(z) \setminus \{z\})$. Consider the function

$$\frac{1}{f(\tilde{z}) - y}$$

defined on $\mathbb{D}_\delta(z) \setminus \{z\}$. Thus it admits a holomorphic extension to the whole disk $D_\delta(z)$. Let us now distinguish the cases in which $h(z) \neq 0$ and $h(z) = 0$. In the first case let

$$h(\tilde{z}) = \frac{1}{f(\tilde{z}) - y}$$

so that

$$\frac{1}{h(\tilde{z})} = f(\tilde{z}) - y$$

on $\mathbb{D}_{\tilde{\delta}}(z)$ for a sufficiently small $\tilde{\delta} > 0$ and thus the identity

$$f(\tilde{z}) = \frac{1}{h(\tilde{z})} + y$$

holds on $\mathbb{D}_{\tilde{\delta}}(z)$ and defines a holomorphic function. In the case that $h(z) = 0$ we have that

$$\frac{1}{f(\tilde{z})} = \frac{h(\tilde{z})}{1 + yh(\tilde{z})}$$

is holomorphic in $\mathbb{D}_{\tilde{\delta}}(z)$ for $\tilde{\delta}$ small enough and this concludes the proof. \square

At this point we remark that point 3 can be used to define an expansion for meromorphic functions around a given point $z \in \mathbb{C}$. Given a meromorphic function $f: \Omega \rightarrow \mathbb{C} \cup \{\infty\}$ for an open connected domain $\Omega \subset \mathbb{C}$ and for every point $z \in \Omega$ one may write

$$f(\tilde{z}) = \sum_{n=-N}^{+\infty} a_n(\tilde{z} - z)^n. \quad (1.12)$$

The convergence radius r of the series is determined by the positive index coefficients. So this means that the series converges absolutely on $D_{r'}(z) \setminus \{z\}$ and f and the partial sums are uniformly bounded on all coronas of the form

$$\{\tilde{z} \in \mathbb{C}: 0 < \epsilon < |\tilde{z} - z| < r' < r\}$$

Notice that the holomorphic function g appearing in expression (1.11) corresponds to the part of the series with the non-negative index coefficients:

$$g(\tilde{z}) = \sum_{n=0}^{+\infty} a_n(\tilde{z} - z)^n$$

while the negative index coefficients determine the principle part:

$$\sum_{n=-N}^{-1} a_n(\tilde{z} - z)^n$$

Having defined the basic properties of meromorphic functions we will now state and prove a deep structure result. Given a meromorphic function we call the points $z \in \mathbb{C}$ such that f is not holomorphic on any disc $D_\delta(z)$ the “poles” of f . It can be easily seen that the poles of f are the zeroes of $\frac{1}{f}$ and vice versa: the zeroes of f are the poles of $\frac{1}{f}$. Notice that it trivially follows from the definition that f is meromorphic if and only if $\frac{1}{f}$ is meromorphic.

Let γ be a closed² Lipschitz continuous path

$$\gamma: [0, 1] \rightarrow \mathbb{C} \setminus \{0\}$$

and let f be a holomorphic function on a disk $\mathbb{D}_r(0)$ containing the image of γ . The contour integral condition

$$\int_{\gamma} f(z) dz = 0$$

does not hold for meromorphic function. As a matter of fact consider

$$\frac{1}{2\pi i} \int_{\gamma} \frac{1}{z} dz = n_{\gamma,0}$$

where $n_{\gamma,0}$ is the winding number of γ with respect to 0 that is generally non-zero. If f is a meromorphic function we can expand f into its Laurent series. Clearly the holomorphic part doesn't give any contribution to the contour integral. On the other hand the contribution from the principle part amounts only to the one coming from the coefficient $a_{-1}z^{-1}$. As a matter of fact

$$\frac{1}{2\pi i} \int_{\gamma} \sum_{n=1}^N a_{-n} z^{-n} dz = \frac{a_{-1}}{2\pi i} \int_{\gamma} \frac{1}{z} dz = a_{-1} n_{\gamma,0}.$$

This holds since

$$\sum_{n=1}^N a_{-n} z^{-n} = a_{-1} z^{-1} + \underbrace{\sum_{n=2}^N a_{-n} z^{-n}}_{\text{has a primitive}} \quad \text{in } \mathbb{C} \setminus \{0\}.$$

The primitive of $a_{-n} z^{-n}$ with $n \geq 2$ on $\mathbb{C} \setminus \{0\}$ is clearly given by $\frac{a_{-n}}{-n+1} z^{-n+1}$. We call the residue f in the point $z \in \mathbb{C}$ the quantity

$$\text{Res}_z f := a_{-1}$$

where a_{-1} is the -1 -term in the Laurent series of f at $z \in \mathbb{C}$ as in (1.12). Notice that not all functions are meromorphic. Consider a function $f: \Omega \rightarrow \mathbb{C} \cup \{\infty\}$ such that $f(z) = \infty$ only for a discrete set of points and suppose that f is holomorphic on $\Omega \setminus \{z \in \Omega: f(z) = \infty\}$. Recall that $z \in \Omega$ with $f(z) = \infty$ is a pole if $f \upharpoonright_{B_{\delta}(z)}$ is meromorphic for some $\delta > 0$. If no such $\delta > 0$ exists then we call z an *essential singularity*.

²such that $\gamma(0) = \gamma(1)$.

The function $f(z) = e^{1/z}$ is holomorphic on $\mathbb{C} \setminus \{0\}$, however it is not meromorphic on $B_\delta(0)$ for any $\delta > 0$. This can be seen explicitly since neither f nor $\frac{1}{f(z)} = e^{-1/z}$ is holomorphic around 0. Furthermore there is no such $N \in \mathbb{N}$ such that $e^{1/z} z^N$ is holomorphic. The point 0 is thus an essential singularity of $e^{1/z}$.

Proposition 1.57 (Cauchy for meromorphic function). *Let $f: \Omega \rightarrow \mathbb{C} \cup \{\infty\}$ be a meromorphic function with finitely many poles³. Let $\gamma: [a, b] \rightarrow \Omega$ be a continuous path homotopic on Ω to a constant path, such that no poles of f lie in the image of γ . Then*

$$\int_{\gamma} f(z) dz = 2\pi i \sum_{j=1}^N \text{Res}(f, z_j) n_{\gamma, z_j},$$

where z_1, \dots, z_n are poles of f .

There is no loss of generality in assuming that the number of poles of f are finite. As a matter of fact, since the poles of f are the zeroes of $1/f$ that is holomorphic on $\Omega \setminus \{z \in \Omega: f(z) = 0\}$ they are discrete set.

Example 1.58. Let us calculate the integral

$$\int_{-\infty}^{\infty} \frac{1}{1+x^2} dx.$$

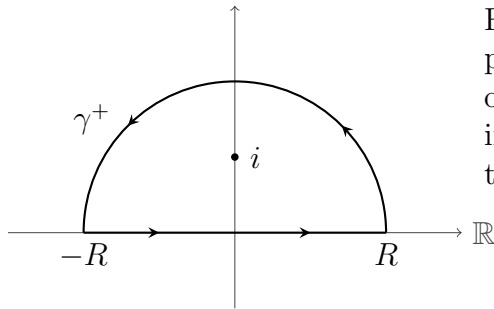

For this purpose we consider the closed path γ_R made up of two parts: $[-R, R]$ on the real line and the semicircle γ^+ in the half-upper plane, as in the picture. The integral over γ_R^+ goes to zero

$$\lim_{R \rightarrow \infty} \int_{\gamma_R^+} \frac{1}{1+z^2} dz = 0$$

since

$$\left| \int_{\gamma_R^+} \frac{1}{1+z^2} dz \right| = \left| \int_0^\pi \frac{1}{1+R^2 e^{2it}} 2iR e^{2it} dt \right| \leq \frac{2\pi}{R}.$$

Thus we have that

$$\int_{-R}^R \frac{1}{1+x^2} dx = \int_{\gamma_R} \frac{1}{1+z^2} dz - \int_{\gamma_R^+} \frac{1}{1+z^2} dz$$

³point $z \in \mathbb{C}$ such that $f(z) = \infty$.

and by taking the limit we obtain

$$\int_{-\infty}^{+\infty} \frac{1}{1+z^2} dz = \lim_{R \rightarrow +\infty} \int_{\gamma_R} \frac{1}{1+z^2} dz.$$

We compute the right hand side using the residue theorem since $\frac{1}{1+z^2}$ is meromorphic on \mathbb{C} :

$$\int_{\gamma_R} \frac{1}{1+z^2} dz = 2\pi i \left(\frac{1}{2i} \right) \underbrace{n_{\gamma, i}}_{=1} = \pi.$$

We obtained the residue by noticing that

$$\frac{1}{1+z^2} = \frac{1}{2i} \left(\frac{1}{z-i} - \frac{1}{z+i} \right).$$

The function $\frac{1}{z+i}$ is holomorphic on $\{z \in \mathbb{C} : \operatorname{Re} z > -1\}$ that contains the image of γ_R so it does not contribute to the principle part of $\frac{1}{1+z^2}$ for any point inside on that domain. On the other hand $\frac{1}{2i}(z-i)^{-1}$ has residue $\frac{1}{2i}$.

Exercise 1.59. Consider the integral

$$I = \int_{-\infty}^{\infty} \frac{e^{ax}}{1+e^x} dx, \quad a \in (0, 1)$$

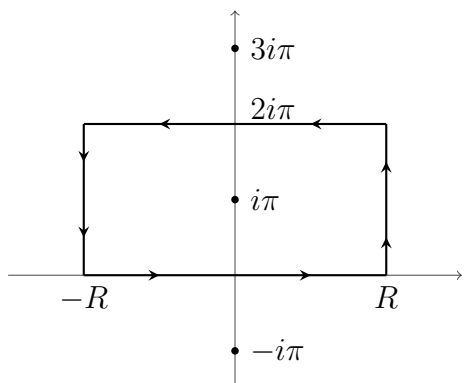

Consider now the closed rectangle as path γ , as in the picture. The integral over the upper edge is equal to:

$$-\int_{-\infty}^{\infty} \frac{e^{a(x+2\pi i)}}{1+e^{x+2\pi i}} dx = -e^{2\pi ia} I$$

moreover, over the sides x is constant, so

$$I(1 - e^{2\pi ia}) = 2\pi i \operatorname{Res}_{i\pi}.$$

◇ ————— End of lecture 09, May 12, 2016 ————— ◇

1.2 The argument principle

The argument principle is a tool to count zeros and poles of meromorphic functions using curve integrals. Let $\Omega \subset \mathbb{C}$ be open and bounded and γ a continuous curve in Ω for which the Cauchy integral theorem holds. Temporarily we assume also $0 \in \Omega$ and $0 \notin \gamma$ for convenience. As we have seen, the complex logarithm is not uniquely determined, but its derivative is: $(\ln(z))' = \frac{1}{z}$. Recall that the winding number of γ around 0 is given by

$$\frac{1}{2\pi i} \int_{\gamma} \ln'(z) dz.$$

We can interpret this integral as counting the zeros of the function $f(z) = z$ within the contour given by γ . Our goal is to generalize this to arbitrary meromorphic functions f .

Let f be a meromorphic function on Ω , $z_0 \in \Omega$ and say that $f(z) = (z - z_0)^N g(z)$, $N \in \mathbb{Z}$ holds in a neighborhood of z_0 , excluding the point z_0 with g holomorphic and $g(z_0) \neq 0$. Then,

$$(\ln \circ f)'(z) = \frac{f'(z)}{f(z)} = \frac{N(z - z_0)^{N-1}g(z) + (z - z_0)^N g'(z)}{(z - z_0)^N g(z)} = \frac{N}{z - z_0} + \frac{g'(z)}{g(z)}.$$

This function has a pole with residue N in the point z_0 and is meromorphic in Ω . We conclude that if f has no poles or zeros on γ , then

$$\frac{1}{2\pi i} \int_{\gamma} \frac{f'}{f} = \sum_z \operatorname{Res}_z \left(\frac{f'}{f} \right) = N_{\gamma}(f) - P_{\gamma}(f),$$

where $N_{\gamma}(f)$ ($P_{\gamma}(f)$) is the number of zeros (poles) of f within the contour γ , where each zero (pole) is counted as many times as the product of winding number and multiplicity indicates.

Theorem 1.60 (Rouché). *Let f, g be meromorphic functions on Ω without poles or zeros on γ , and suppose that for all $z \in \gamma$ we have $|g(z)| < |f(z)|$. Then,*

$$N_{\gamma}(f + g) - P_{\gamma}(f + g) = N_{\gamma}(f) - P_{\gamma}(f).$$

Proof. Define a family of meromorphic functions by $f_t(z) = f(z) + tg(z)$ with $t \in [0, 1]$. Then $f_0 = f$, $f_1 = f + g$. The assumptions imply that f_t is meromorphic on Ω and has no poles or zeros on γ for every t . By the argument principle,

$$N_{\gamma}(f_t) - P_{\gamma}(f_t) = \frac{1}{2\pi i} \int_{\gamma} \frac{f_t'(z)}{f_t(z)} dz.$$

Since integrand is continuous in z and γ is continuous, the integrand is uniformly bounded in t . By the uniform convergence theorem, the right hand side is therefore a continuous function in t . On the other hand that function takes only values in \mathbb{Z} . Therefore it must be constant. \square

Remark 1.61. As an application we obtain a proof of the *fundamental theorem of algebra* (already proven in the exercises using the maximum principle). Let $p(z) = a_n z^n + \dots + a_0$ be a polynomial of degree n . Applying Rouché's theorem to $f(z) = a_n z^n$, $g(z) = a_{n-1} z^{n-1} + \dots + a_0$ and γ a sufficiently large circle we see that p has exactly n zeros (counted with multiplicity).

1.3 The Riemann sphere

Meromorphic functions take values in $\mathbb{C}^* = \mathbb{C} \cup \{\infty\}$. Now we introduce the structure of a one-dimensional complex manifold (or Riemann surface) on \mathbb{C}^* that allows us to view meromorphic functions as \mathbb{C}^* -valued holomorphic functions.

Definition 1.62. A *Riemann surface* is a set X with an associated set \mathcal{A} , called *atlas*, of injective maps $\varphi_a : U_a \rightarrow V_a \subset \mathbb{C}$, called *charts*, such that the following properties hold:

1. $\bigcup_{a \in \mathcal{A}} U_a = X$ (the charts cover X), and
2. for $a, b \in \mathcal{A}$, $\varphi_b(U_a \cap U_b) \subset V_b$ is open and $\varphi_a \circ \varphi_b^{-1}$ is holomorphic on that set.

Remark 1.63. One usually considers certain equivalence classes of atlases that are called *complex structures*. We will not go into that in the moment.

Examples 1.64. 1. Every open set $\Omega \subset \mathbb{C}$ is a Riemann surface with atlas $\mathcal{A} = \{\text{id} : \Omega \rightarrow \Omega\}$.

2. The set \mathbb{C}^* is a Riemann surface, called the *Riemann sphere*. An atlas is $\mathcal{A} = \{\varphi_0, \varphi_1\}$ with $\varphi_0 = \text{id} : \mathbb{C} \rightarrow \mathbb{C}$ and $\varphi_1 : \mathbb{C}^* \setminus \{0\} \rightarrow \mathbb{C}$, $z \mapsto \frac{1}{z}$.

Definition 1.65. Let X_1, X_2 be Riemann surfaces. A function $f : X_1 \rightarrow X_2$ is called *holomorphic* if for all charts $\varphi_i : U_i \rightarrow V_i$ on X_i , $i = 1, 2$ the set $\varphi_1(f^{-1}(U_2) \cap U_1)$ is open and the function $\varphi_2 \circ f \circ \varphi_1^{-1}$ is holomorphic on that set.

Example 1.66. For functions $\Omega \rightarrow \mathbb{C}$ with $\Omega \subset \mathbb{C}$ open, this coincides with the already established notion of holomorphicity.

1.4 Möbius transforms

Definition 1.67. Let $\begin{pmatrix} a & b \\ c & d \end{pmatrix}$ be an invertible complex matrix. The corresponding Möbius transform is the map $\varphi : \mathbb{C}^* \rightarrow \mathbb{C}^*$ given by

$$z \mapsto \begin{cases} \frac{az+b}{cz+d}, & \text{if } z \neq \infty, \\ \frac{a}{c}, & \text{if } z = \infty \end{cases}$$

with the usual convention that $\frac{z}{0} = \infty$ if $z \neq 0$ ($\frac{0}{0}$ does not occur).

Lemma 1.68. Let $A = \begin{pmatrix} a & b \\ c & d \end{pmatrix}$ and $\tilde{A} = \begin{pmatrix} \tilde{a} & \tilde{b} \\ \tilde{c} & \tilde{d} \end{pmatrix}$ be invertible and $\varphi, \tilde{\varphi}$ the respective corresponding Möbius transforms. Then $\varphi \circ \tilde{\varphi}$ is the Möbius transform corresponding to the matrix $A\tilde{A}$.

Proof.

$$\frac{a\frac{\tilde{a}z+\tilde{b}}{\tilde{c}z+\tilde{d}}+b}{c\frac{\tilde{a}z+\tilde{b}}{\tilde{c}z+\tilde{d}}+d} = \frac{a(\tilde{a}z+\tilde{b})+b(\tilde{c}z+\tilde{d})}{c(\tilde{a}z+\tilde{b})+d(\tilde{c}z+\tilde{d})} = \frac{(a\tilde{a}+b\tilde{c})z+(a\tilde{b}+b\tilde{d})}{(c\tilde{a}+d\tilde{c})z+(c\tilde{b}+d\tilde{d})}.$$

It remains to treat the special cases $z = \infty$ and $\tilde{\varphi}(z) = \infty$. This is left as an exercise to the reader. \square

Corollary 1.69. Every Möbius transform is invertible and the inverse is again a Möbius transform.

Lemma 1.70. Every Möbius transform is a holomorphic map $\mathbb{C}^* \rightarrow \mathbb{C}^*$.

This can be checked directly from the definitions (exercise).

Theorem 1.71. The biholomorphic maps $\mathbb{C}^* \rightarrow \mathbb{C}^*$ are exactly the Möbius transforms.

To prove this we need the following lemma.

Lemma 1.72. Möbius transforms act transitively on \mathbb{C}^* . That is, for every $z_0, w_0 \in \mathbb{C}^*$ there exists a Möbius transform φ such that $\varphi(z_0) = w_0$.

Proof. If $z_0 = \infty, w_0 \neq \infty$ choose $\varphi(z) = \frac{1}{z} + w_0$. If $z_0 \neq \infty, w_0 \neq \infty$ choose $\varphi(z) = z - z_0 + w_0$. If $z_0 \neq \infty, w_0 = \infty$ choose $\varphi(z) = \frac{1}{z-z_0}$. If $z_0 = w_0 = \infty$ choose $\varphi = \text{id}$. \square

Proof of Theorem 1.71. We already know that Möbius transforms are biholomorphic. Let $\psi : \mathbb{C}^* \rightarrow \mathbb{C}^*$ be a biholomorphic map and φ a Möbius transform with $\varphi(\psi(\infty)) = \infty$ (exists by previous lemma). Then $\varphi \circ \psi$ is a biholomorphic map $\mathbb{C}^* \rightarrow \mathbb{C}^*$ and the restriction $\varphi \circ \psi \upharpoonright_{\mathbb{C}}$ is a biholomorphic map $\mathbb{C} \rightarrow \mathbb{C}$. By Theorem 1.27 we conclude that $\varphi \circ \psi$ is an affine linear map (in particular, a Möbius transform). Thus also $\psi = \varphi^{-1} \circ (\varphi \circ \psi)$ is a Möbius transform. \square

◇ ————— End of lecture 10. May 23, 2016 ————— ◇

2 Riemann Mapping Theorem

We have seen last time that a bijective holomorphic function from $f : \mathbb{C}^* \rightarrow \mathbb{C}^*$ is a Möbius transform. Such a result can be seen as a rigidity result for the Riemann sphere \mathbb{C}^* . In similar spirit we will now try to classify the open domains $\Omega \subset \mathbb{C}$. In particular we will study when given two open domains there exists a biholomorphic bijection between them. Without loss of generality we can suppose that any domain Ω we consider is an open subset of \mathbb{C} . Clearly if $\Omega \neq \mathbb{C}^*$ (a case we already classified) then up to a Möbius transform we can suppose that $\infty \notin \Omega$.

Theorem 2.1 (Riemann Mapping Theorem). *Let $\Omega \subset \mathbb{C}$, $\Omega \notin \{\emptyset, \mathbb{C}\}$, be a connected and simply connected open domain. Then there exists a holomorphic bijection $f : \Omega \rightarrow \mathbb{D}$ of Ω onto the unit disk.*

Let us start with some examples

Example 2.2. Let $\Omega = \{z \in \mathbb{C} : \operatorname{Re}(z) > 0\}$ then the desired mapping is given by $f(z) = \frac{z-1}{z+1}$. As a matter of fact

$$|f(x+iy)|^2 = \left| \frac{x+iy-1}{x+iy+1} \right|^2 = \frac{(x-1)^2 + y^2}{(x+1)^2 + y^2} < 1 \quad \text{when } x > 0.$$

We can see that the map f is surjective onto the disk \mathbb{D} by showing that the inverse map is given by $g(z) = \frac{z+1}{-z+1}$.

Example 2.3. Let $\Omega = \mathbb{C} \setminus \{z \in \mathbb{C} : \operatorname{Im}(z) = 0, \operatorname{Re}(z) \geq 0\}$. Consider the function

$$f : z \mapsto z^2$$

that sends the set $\{z \in \mathbb{C} : \operatorname{Re}(z) > 0\}$ onto Ω . It is bijective and biholomorphic. By using the previous example we can then construct a bijective biholomorphism between $\{z \in \mathbb{C} : \operatorname{Re}(z) > 0\}$ and \mathbb{D} concluding the example.

Now let us illustrate negative example.

Example 2.4. Suppose that the open domain is $\Omega = \mathbb{C}$ and consider any holomorphic function $f : \Omega \rightarrow \mathbb{D}$. By Liouville's Theorem, being f a bounded function, we have that $f = c \in \mathbb{D}$ showing that f cannot be a bijection with \mathbb{D} .

Proof of the Riemann Mapping Theorem. First we reduce to the case that Ω is a bounded domain. Let Ω be as in the statement of the Theorem. Since $\Omega \neq \mathbb{C}$ there exists $z_0 \notin \Omega$ and we may suppose that $z_0 = 0$ by applying a translation map $\Omega \mapsto \Omega - z_0$. Since Ω is simply connected we can define the complex logarithm as a holomorphic function $\ln(z)$ on Ω . In particular we have that

$$\left(e^{\frac{1}{2}\ln z}\right)^2 = z$$

i.e. the map $f(z) = e^{\frac{1}{2}\ln z}$ satisfies the functional equation $f(z)^2 = z$ and f is holomorphic and injective. It is furthermore an open mapping and is a bijection with $\tilde{\Omega} = f(\Omega)$.

Furthermore the functional equation shows that the inverse of f on $\tilde{\Omega}$ is given by the mapping $z \mapsto z^2$. To conclude our reduction let us show that $\tilde{\Omega}$ is bounded. Let $z_1 \in \tilde{\Omega}$. Since the map $z \mapsto z^2$ is the inverse of f then it must be injective on $\tilde{\Omega}$. Thus there exists $\epsilon > 0$ such that

$$\mathbb{D}_\epsilon(z_1) \subset \tilde{\Omega} \qquad \mathbb{D}_\epsilon(-z_1) \cap \tilde{\Omega} = \emptyset.$$

Consider the function $g(z) = \frac{1}{z+z_1}$ defined on $\tilde{\Omega}$. It is injective on $\tilde{\Omega}$ and its image is an open bounded set $\tilde{\tilde{\Omega}}$. Since

$$f : \Omega \rightarrow \tilde{\Omega} \qquad g : \tilde{\Omega} \rightarrow \tilde{\tilde{\Omega}}$$

are both biholomorphic bijections with their respective images. We have thus reduced the proof of the Theorem to showing that there exists a holomorphic bijection $\tilde{\tilde{\Omega}} \rightarrow \mathbb{D}$, and the former is a bounded domain.

Without loss of generality we can suppose that Ω is bounded and $0 \in \Omega$. First of all consider the set \mathcal{F} of all injective holomorphic maps $f : \Omega \mapsto \mathbb{D}$ with $f(0) = 0$. This set is non-empty since

$$f(z) = \epsilon z \qquad 0 < \epsilon \ll 1$$

is such a function given that Ω is bounded. We also have that

$$\sup_{f \in \mathcal{F}} |f'(0)| < \infty.$$

As a matter of fact suppose that $\mathbb{D}_{2\delta}(0) \subset \Omega$. We can obtain the value of $f'(0)$ as a contour integral:

$$f'(0) = \frac{1}{2\pi i} \int_{\partial\mathbb{D}_\delta(0)} \frac{f(z)}{z^2} dz.$$

This expression follows from the residue theorem applied to the meromorphic function $\frac{f(z)}{z^2}$ on $\mathbb{D}_{2\delta}(0)$. We thus have

$$|f'(0)| = \left| \frac{1}{2\pi i} \int_{\partial\mathbb{D}_\delta(0)} \frac{f(z)}{z^2} dz \right| \leq \frac{1}{\delta}$$

since $|f(z)| < 1$. The main idea of the proof is to look for $f \in \mathcal{F}$ so that $|f'(0)|$ is maximal. We will continue the proof after an illustrative example...

Example 2.5 (Schwarz Lemma). Let $f : \mathbb{D} \rightarrow \mathbb{D}$ be a holomorphic function with $f(0) = 0$ then $|f'(0)| \leq 1$ and if $|f'(0)| = 1$ then f is bijective.

Proof. The proof is based on applying the maximum principle. Since $f(0) = 0$ then

$$g(z) := \frac{f(z)}{z}$$

is a holomorphic function on \mathbb{D} . Furthermore $|g(z)| \leq 1 + \epsilon$ if $|z| > \frac{1}{1+\epsilon}$ so using the maximum principle we have that $|g(z)| \leq 1 + \epsilon$ for all $z \in \mathbb{D}$. This holds for any $\epsilon > 0$ and thus $|g(z)| \leq 1$ so we have that

$$|f(z)| \leq |z| \quad \forall z \in \mathbb{D}$$

Similarly, if $|f(z)| = |z|$ for some $z \in \mathbb{D} \setminus \{0\}$ then $|g(z)| = 1$ in that point and thus again by the maximum $g(z) = \frac{f(z)}{z}$ is constant so.

$$f(z) = \lambda z \quad |\lambda| = 1.$$

Notice that $g(0) := f'(0)$ since

$$g(0) = \lim_{z \rightarrow 0} g(z) = \lim_{z \rightarrow 0} \frac{f(z)}{z} = \lim_{z \rightarrow 0} \frac{f(z) - f(0)}{z - 0}$$

so $|f'(0)| \leq 1$ and if $|f'(0)| = |g(0)| = 1$ then

$$f(z) = \lambda z \quad |\lambda| = 1.$$

once again. □

Let us now return to the original idea of looking for $f \in \mathcal{F}$ with maximal $|f'(0)|$. Let $f_n : \Omega \rightarrow \mathbb{D}$ be a sequence of functions in \mathcal{F} such that $\lim_{n \rightarrow \infty} |f'_n(0)| = \sup_{f \in \mathcal{F}} |f'(0)|$.

We will now show that f_n has a subsequence that converges locally uniformly i.e. for all $z \in \Omega$ there exists $\epsilon_z > 0$ such that $f_n \upharpoonright_{\mathbb{D}_{\epsilon_z}(z)}$ converges uniformly. Notice that the pointwise limit function $f = \lim f_n$ is still holomorphic. This follows from the condition of having vanishing integrals over all sufficiently small closed contours that is stable under locally uniform convergence.

Lemma 2.6. *Let $f_n : \mathbb{D} \rightarrow \mathbb{D}_R(0)$ a sequence of holomorphic functions. Then there exists a subsequence that converges uniformly on any disk $\mathbb{D}_r(0)$ with $r < 1$.*

Proof. Let us choose $r < 1$. The derivatives f'_n are bounded on $\overline{\mathbb{D}_r(0)}$ via the Cauchy integral formula:

$$f'_n(z_0) = \frac{1}{2\pi i} \int_{\partial \mathbb{D}_{(1+r)/2}(0)} \frac{f_n(z)}{(z - z_0)^2} dz \quad \forall z \in \mathbb{D}_r(0)$$

$$|f'_n(z_0)| \leq \frac{2R}{|1 - r|}.$$

The statement follows by the Ascoli-Arzelá since f_n are all uniformly bounded and $\frac{2R}{|1-r|}$ -Lipschitz on $\mathbb{D}_r(0)$. Finally one can apply a diagonal argument to obtain convergence on any disc $\mathbb{D}_r(0)$.

We provide a sketch of the proof of one of the implications of the Ascoli-Arzelá theorem. Specifically, let \mathcal{F} be a set of uniformly bounded continuous functions on a compact metric space K such that all $f \in \mathcal{F}$ are L -Lipschitz with a common coefficient $L > 0$. Then the set \mathcal{F} is sequentially precompact i.e. given any sequence $(f_n)_{n \in \mathbb{N}} \subset \mathcal{F}$ there exists a uniformly convergent subsequence $f_{n_m} \rightarrow f$. Since K is compact then for any $\epsilon > 0$ one can cover K by finitely many ϵ -balls:

$$K \subset \bigcup_{n=1}^{N_\epsilon} B_\epsilon(x_n).$$

For each $k > 0$ consider $\epsilon = 2^{-k}$ and the associated centers of the ϵ -ball covering. Then number all the points to obtain a unique sequence x_n . Given a sequence of functions f_n one uses a diagonal argument to select a subsequence that converges pointwise on all points $(x_n)_{n \in \mathbb{N}}$. Suppose we have selected a subsequence $f_{n,m}$ such that $f_{n,m}(x_{m'})$ is a Cauchy sequence for all $0 < m' < m$. Clearly $f_{n,m}(x_m)$ is bounded so it has an accumulation point. We can thus extract a subsequence $f_{n,m+1}$ that converges on $x_{m'}$ for all $m' \leq m$.

The diagonal argument consist of choosing the sequence $f_{n,n}$ that clearly converges on x_m for all $m \in \mathbb{N}$. Let us now restrict to this subsequence and for ease of nation call it f_n .

For any $\epsilon > 0$ choose $M_\epsilon > 0$ large enough such that

$$K \subset \bigcup_{n=1}^{M_\epsilon} B_\epsilon(x_n)$$

and choose $N > 0$ large enough such that $|f_{n'}(x_m) - f_n(x_m)| < \epsilon$ for all $n, n' > N$ and $0 < m < M_\epsilon$. This can be done since the number of points x_m considered is finite. At this point for any $x \in K$ we have the estimate

$$\begin{aligned} |f_n(x) - f_{n'}(x)| &\leq |f_n(x_m) - f_n(x)| + |f_{n'}(x_m) - f_n(x_m)| + |f_{n'}(x_m) - f_{n'}(x)| \\ &< \epsilon + 2L|x - x_m| < (2L + 1)\epsilon \end{aligned}$$

where the last estimate holds using the Lipschitz condition as long as we choose x_m such that $x \in B_\epsilon(x_m)$. This shows that f_n is a Cauchy sequence in the supremum norm.

This argument applies to our case and another diagonal argument with $r_n = 1 - 2^{-n}$ gives the statement of the Lemma (left to the reader). \square

Using the above Lemma, an approximation argument by compact sets, and a diagonal argument one can obtain the needed subsequence of $f_n \in \mathcal{F}$ that converges locally uniformly on Ω .

Now let $f = \lim_{n \rightarrow \infty} f_n$

Proof of the Riemann Mapping Theorem (continued).

- f is holomorphic on Ω and its image is in \mathbb{D} . This follows from the fact that f is a continuous map, its image is contained in \mathbb{D} (via uniform convergence), and finally it is holomorphic since for small enough disks $\mathbb{D}_\epsilon(z_0) \subset \Omega$ and any closed Lipschitz path $\gamma : [0, 1] \rightarrow \mathbb{D}_\epsilon(z_0)$ we have that

$$\int_\gamma f(z)dz = \lim_{n \rightarrow \infty} \int_\gamma f_n(z)dz = 0.$$

The limit exits because of uniform convergence of f_n

- Using Cauchy's formula one can similarly show that $f'(z_0) = \lim_{n \rightarrow \infty} f'_n(z_0)$. Notice furthermore that using locally uniform convergence and Cauchy's formula

$$f'(z_0) = \frac{1}{2\pi i} \int_{\partial \mathbb{D}_{\delta/2}(z_0)} \frac{f(z)}{(z - z_0)^2} dz$$

one can obtain that f'_n also converge locally uniformly.

- The limit function f is injective. Reasoning by contradiction suppose that $f(z_1) = f(z_2) = c$. Then $f - c$ has at least two isolated zeroes: z_1 and z_2 that are isolated. Take a path $\gamma: [0, 1] \rightarrow \partial A$ with A an open, connected, simply connected, set with $\overline{A} \subset \Omega$ such that A contains both z_1 and z_2 and no other zeroes lie on \overline{A} . One has

$$\frac{1}{2\pi i} \int_{\gamma} \frac{f'(z)}{f(z) - c} dz = 2 = \lim_{n \rightarrow \infty} \frac{1}{2\pi i} \int_{\gamma} \frac{f'_n(z)}{f_n(z) - c} dz.$$

The second limit holds because of locally uniform convergence of f_n and f'_n the image of γ . Furthermore for large enough n the quantity $f_n(z) - c$ is non-vanishing on ∂A . Since f_n is injective the right hand side is at most 1 that leads to a contradiction.

- f is surjective. We postpone the proof to the next lecture.

□

◇ ————— End of lecture 11, May 30, 2016 ————— ◇

The proof of the Riemann mapping theorem may look complicated at a first glance but it is in fact simple. Let us summarize it.

1. There exists an injective holomorphic map $g : \Omega \rightarrow \mathbb{D}$, $g(0) = 0$ (after reduction to a bounded Ω , $g(z) = \varepsilon z$) (B1)
2. For all such maps we have $|g'(0)| < C_{\Omega} < \infty$. (This is because we can write that derivative as a Cauchy integral estimate that using that g maps into \mathbb{D} .) Now try to maximize $|g'(0)|$ using a compactness argument.
3. This extremizing g is really surjective.

Let g be extremizing in the above sense and φ a Möbius transform with $0 \notin \text{im}(\varphi \circ g)$. Suppose that g is not surjective on \mathbb{D} .

We find $h : \Omega \rightarrow \mathbb{D}$ with $h^2 = \varphi \circ g$. Then find a Möbius transform ψ with $\psi \circ h(0) = 0$. Set $k = \psi \circ h$, $k : \Omega \rightarrow \mathbb{D}$. With $s(z) = z^2$ we have

$$g = \varphi^{-1} \circ s \circ \psi^{-1} \circ k.$$

Thus,

$$g'(0) = (\varphi^{-1} \circ s \circ \psi^{-1})'(k(0))k'(0).$$

Now we notice that $|(\varphi^{-1} \circ s \circ \psi^{-1})'(k(0))| < 1$ by the Schwarz lemma.

The Riemann mapping theorem can be used to construct many other interesting holomorphic functions.

Green's function. Given a Riemann map $f : \Omega \rightarrow \mathbb{D}$, we consider the real-valued function $\ln |f|$. This is Green's function. Note that this is a real-valued function and no longer holomorphic. It is however a *harmonic* function. Before we come to the properties of Green's functions we discuss harmonic functions in general.

Definition 2.7. Let $\Omega \subset \mathbb{C}$ be open. $f : \Omega \rightarrow \mathbb{R}$ is called *harmonic* if f is twice continuously differentiable with

$$\Delta f = \partial_x^2 f + \partial_y^2 f = 0.$$

Theorem 2.8. Let $f : \Omega \rightarrow \mathbb{R}$ be harmonic and $\tilde{\Omega} \subset \Omega$ open and simply connected. Then there exists $g : \tilde{\Omega} \rightarrow \mathbb{C}$ holomorphic with $\operatorname{Re}(g) = f \upharpoonright_{\tilde{\Omega}}$.

Example 2.9. The function $\mathbb{C} \setminus \{0\} \rightarrow \mathbb{R}$, $z \mapsto \ln |z|$ is a harmonic function. On $\tilde{\Omega}$ we have $\operatorname{Re} \ln(z) = \ln |z|$ (note that this does not make sense on all of $\mathbb{C} \setminus \{0\}$).

Proof of Theorem 2.8. Consider $\partial_x f - i\partial_y f = u + iv$ with u, v continuously differentiable real-valued functions. Then

$$\begin{aligned} \partial_x u &= \partial_x^2 f = -\partial_y^2 f = \partial_y v, \\ \partial_y u &= \partial_y \partial_x f = \partial_x \partial_y f = -\partial_x v \end{aligned}$$

So $u + iv$ satisfies the Cauchy-Riemann equations and therefore $u + iv$ has a holomorphic primitive g on $\tilde{\Omega}$. We have

$$u + iv = \partial_z g = \frac{1}{2}(\partial_x - i\partial_y)(\operatorname{Re} g + i\operatorname{Im} g) = \frac{1}{2}(\partial_x \operatorname{Re} g + \overbrace{\partial_y \operatorname{Im} g}^{=\partial_x \operatorname{Re} g}) + \frac{i}{2}(\overbrace{\partial_x \operatorname{Im} g}^{=-\partial_y \operatorname{Re} g} - \partial_y \operatorname{Re} g).$$

Thus $\partial_x f = u = \partial_x \operatorname{Re} g$ and $\partial_y f = -v = \partial_y \operatorname{Re} g$. That is, $\nabla f = \nabla \operatorname{Re} g$, so f equals $\operatorname{Re} g$ up to an additive constant. That constant can be incorporated into the function g . \square

Theorem 2.10. Let $f : \Omega \rightarrow \mathbb{R}$. If for all $z \in \Omega$ there exists $\varepsilon > 0$, $D_\varepsilon(z) \subset \Omega$ with $f \upharpoonright_{D_\varepsilon(z)} = \operatorname{Re}(g)$, $g : D_\varepsilon(z) \rightarrow \mathbb{C}$ holomorphic, then f is harmonic.

Proof. First, f is infinitely often differentiable on $D_\varepsilon(z)$. Then, using the Cauchy-Riemann equations, we compute

$$\partial_x^2 f + \partial_y^2 f = \partial_x^2 \operatorname{Re} g + \partial_y^2 \operatorname{Re} g = \partial_x \partial_y \operatorname{Im} g - \partial_y \partial_x \operatorname{Im} g = 0.$$

\square

Theorem 2.11. Let $f : \Omega \rightarrow \mathbb{R}$ be harmonic and $D_{2\varepsilon}(z) \subset \Omega$. Then,

$$2\pi f(z) = \int_0^{2\pi} f(z + \varepsilon e^{i\varphi}) d\varphi = \int_{\mathbb{R}^2} f(x, y) \delta\left(\frac{\varepsilon^2 - |(x, y) - z|^2}{2}\right) dx dy$$

The proof is using the Cauchy integral for an appropriate holomorphic function (exercise).

Definition 2.12. Let $f : \Omega \rightarrow \mathbb{D}$ be holomorphic and bijective with $f(z_0) = 0$. Then $\log |f| : \Omega \setminus \{z_0\} \rightarrow \mathbb{R}$ is called a *Green's function* of Ω with respect to z_0 .

Theorem 2.13. Let G be a Green's function of Ω with respect to z_0 . Then G

1. is negative: $\Omega \setminus \{z_0\} \rightarrow (-\infty, 0]$,
2. is harmonic,
3. has a log-singularity in z_0 in the sense that $G - \ln |z - z_0|$ has a harmonic extension on Ω , and
4. has a continuous extension on $\partial\Omega \cup \Omega \setminus \{z_0\}$ with $G \upharpoonright_{\partial\Omega} \equiv 0$.

It is a natural question if and when also the Riemann map f can be extended to the boundary and if yes, how it behaves on the boundary. This is a more subtle issue. We will consider such questions another time.

Proof. We prove only the last property. The remaining properties are left to the reader as an exercise. Let $y \in \partial\Omega$ and $z_n \in \Omega$ with $\lim_{n \rightarrow \infty} z_n = y$. We need to show that $\lim_{n \rightarrow \infty} G(z_n) = 0$.

Let $\varepsilon > 0$ and K the preimage of $\overline{D_{e^{-\varepsilon}}(0)}$ under the Riemann map f . Then K is compact. $y \notin K$, so there is δ with $D_\delta(y) \cap K = \emptyset$. Let N be so that for all $n > N$ we have $|z_n - y| < \delta$, $f(z_n) \notin \overline{D_{e^{-\varepsilon}}(0)}$, $|f(z_n)| > e^{-\varepsilon}$, $0 > \ln |f(z_n)| > -\varepsilon$. \square

Exercise. G is uniquely determined by these properties (hint: use the maximum principle; harmonic functions satisfy the maximum principle as can be seen from the mean value property).

Theorem 2.14 (Maximum principle). *Let $f : \Omega \rightarrow \mathbb{R}$ be harmonic and Ω simply connected. Assume that f attains its maximum in $z \in \Omega$. Then f is constant.*

This is a consequence of the mean value property for harmonic functions.

Theorem 2.15. *Let $g : \Omega \rightarrow \tilde{\Omega}$ be holomorphic and $f : \tilde{\Omega} \rightarrow \mathbb{R}$ harmonic. Then $f \circ g : \Omega \rightarrow \mathbb{R}$ is also harmonic.*

This follows from the characterization of harmonic functions being (locally) the real part of holomorphic functions.

One can prove the mean value property for harmonic functions also by real analysis, without the detour to holomorphic functions. More generally, if one takes an arbitrary point in the interior of a disc rather than the center, one should also be able to compute the value of the harmonic function at that point from the values on the boundary of the disc. The precise formula can be derived by mapping the point into the center using a Möbius transform and then invoking the mean value property.

An alternative approach is using Green's function. Let us see how.

Let $\Omega \subset \mathbb{C}$ be open, simply connected and bounded, $z_0 \in \Omega$. Recall that a function $f : \Omega \setminus \{z_0\} \rightarrow \mathbb{R}$ is a Green's function of Ω with respect to z_0 if

1. $f(z) - \log |z - z_0|$ has a harmonic extension to Ω .
2. If $y \in \partial\Omega$, $\lim_{n \rightarrow \infty} z_n = y$, $z_n \in \Omega \setminus \{z_0\}$, then $\lim_{n \rightarrow \infty} f(z_n) = 0$.

Last time we also asked negativity and harmonicity but this already follows from these properties.

The Green's function is uniquely determined (given Ω and z_0): suppose f, \tilde{f} are two Green's functions of Ω with respect to z_0 . Then

$$f - \tilde{f} = f - \ln |z - z_0| - (\tilde{f} - \ln |z - z_0|)$$

has a harmonic extension to Ω and $\tilde{f} \upharpoonright_{\partial\Omega} = 0$. Since $\Omega \cup \partial\Omega$ is compact, $f - \tilde{f}$ has a maximum. If $\max(f - \tilde{f}) \neq 0$ then $f - \tilde{f} = \text{const} = 0$ by the maximum (or minimum) principle. If $\max(f - \tilde{f}) = 0$ then $\tilde{f} - f \equiv 0$.

If $f : \Omega \rightarrow \mathbb{D}$ is a Riemann map with $f(z_0) = 0$ then $\ln|f|$ is a Green's function.

Let f be a Green's function of \mathbb{D} with respect to $z_0 \in \Omega$. Let g be harmonic on Ω with continuous extension to the boundary $\partial\mathbb{D}$. Let $\varepsilon > 0$ and h be a smooth function on \mathbb{R}^2 with

$$\begin{aligned} h(z) &= \frac{|z|^2 - 1}{2} \text{ for } z \text{ close to } \partial\mathbb{D}, \\ h(z) &= -\frac{|z - z_0|^2 - \varepsilon^2}{2} \text{ for } z \in D_\varepsilon(z_0), \\ h(z) &< 0 \iff z \in \mathbb{D} \setminus D_\varepsilon(z_0), \\ h(z) &= 0 \iff z \in \partial\mathbb{D}, z \in \partial D_\varepsilon(z_0). \end{aligned}$$

Integration by parts gives

$$\begin{aligned} &\int_{\mathbb{R}^2} (\Delta g) f \mathbf{1}_- \circ h dx \\ &+ \int_{\mathbb{R}^2} (\nabla g \cdot \nabla f) \mathbf{1}_- \circ h dx \\ &+ \int_{\mathbb{R}^2} \nabla g \cdot f \cdot \nabla h \cdot (-\delta \circ h) dx = 0. \end{aligned}$$

where $\mathbf{1}_-(x) = \mathbf{1}_{(-\infty, 0)}(x)$. To make this precise approximate $\mathbf{1}_-$ by smooth functions and take limits. Integrating by parts again and noting that g and f are harmonic and $\mathbf{1}_- \circ h$ is supported in \mathbb{D} ,

$$0 = \int_{\mathbb{R}^2} \Delta g \cdot f \cdot \mathbf{1}_- \circ h dx - \int_{\mathbb{R}^2} g \cdot \Delta f \cdot \mathbf{1}_- \circ h dx = \int_{\mathbb{R}^2} \nabla g \cdot f \cdot \nabla h \cdot \delta \circ h dx - \int_{\mathbb{R}^2} g \cdot \nabla f \cdot \nabla h \cdot \delta \circ h dx.$$

Decompose

$$\mathbb{R}^2 = A \cup B$$

where A, B are as in the picture:

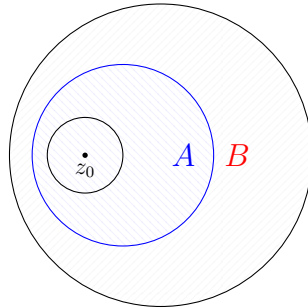

Let us compute the integral over A and B separately. We have

$$\int_B \nabla g \cdot f \cdot \nabla h \cdot \delta \circ h dx = 0.$$

because $f \equiv 0$ on $\partial\mathbb{D}$. So it remains to compute

$$- \int_B g \cdot \nabla f \cdot \underbrace{\nabla h}_{=(x_1, x_2)} \cdot \delta \circ h dx.$$

$((x_1, x_2)$ is a unit vector)

Calculat

$$f(z) = \ln \left| \frac{z - z_0}{1 - z\bar{z}_0} \right| = \operatorname{Re} \ln \underbrace{\frac{z - z_0}{1 - z\bar{z}_0}}_{=: w} = \operatorname{Re} w.$$

Further

$$\nabla f = \operatorname{Re} w' - \operatorname{Im} w'$$

$$w(z) = \ln(z - z_0) - \ln(1 - z\bar{z}_0)$$

$$w'(z) = \frac{1}{z - z_0} + \frac{\bar{z}_0}{1 - z\bar{z}_0} = \frac{z\bar{z}}{z - z_0} + \frac{\bar{z}\bar{z}_0}{\bar{z} - \bar{z}_0} = \bar{z} \left(\frac{z}{z - z_0} + \frac{\bar{z}_0}{\bar{z} - \bar{z}_0} \right) = \bar{z} \left(\frac{z_0}{z - z_0} + \frac{\bar{z}}{\bar{z} - \bar{z}_0} \right)$$

The last equality holds because

$$\frac{z}{z - z_0} + \frac{\bar{z}_0}{\bar{z} - \bar{z}_0} = \frac{z(\bar{z} - \bar{z}_0) + \bar{z}_0(z - z_0)}{|z - z_0|^2} = \frac{1 - |z_0|^2}{|z - z_0|^2} \in \mathbb{R}$$

Thus taking the mean value of the last two terms in the previous chain of equalities we obtain

$$w'(z) = \bar{z} \cdot \operatorname{Re} \left(\frac{z + z_0}{z - z_0} \right).$$

Plugging this into our integral we see that it equals

$$- \int_B g \cdot \operatorname{Re} \left(\frac{z + z_0}{z - z_0} \right) \delta \circ h dx = - \int_0^{2\pi} g(e^{i\varphi}) \operatorname{Re} \left(\frac{e^{i\varphi} + z_0}{e^{i\varphi} - z_0} \right) d\varphi$$

The weight $\operatorname{Re} \left(\frac{e^{i\varphi} + z_0}{e^{i\varphi} - z_0} \right)$ in that integral is the *Poisson kernel*.

It remains to compute the integral on A . To this end we write

$$f = \underbrace{(f - \ln |z - z_0| + \ln \varepsilon)}_{\text{harmonic in } \mathbb{D}} + \underbrace{(\ln |z - z_0| - \ln \varepsilon)}_{\text{Green function of } D_\varepsilon(z_0) \text{ wrt. } z_0}$$

The idea is to treat these terms separately doing similar calculations as before (exercise). In the end the term in question equals

$$\int_0^{2\pi} g(z_0 + \varepsilon e^{i\varphi}) d\varphi$$

As $\varepsilon \rightarrow 0$ this converges to $2\pi g(z_0)$.

Altogether we proved the following:

Theorem 2.16 (Poisson formula). *Let f be a harmonic function on \mathbb{D} that extends continuously to $\partial\mathbb{D}$. Then for all $z \in \mathbb{D}$ we have*

$$f(z) = \frac{1}{2\pi} \int_0^{2\pi} f(e^{i\varphi}) \operatorname{Re} \left(\frac{e^{i\varphi} + z}{e^{i\varphi} - z} \right) d\varphi.$$

As hinted before a simpler alternative proof is via Möbius transforms and the mean value property. However the proof we sketched here has the feature of being purely real-valued.

In some sense the Poisson formula can be seen as a real-valued substitute for the Cauchy integral formula.

We go on to describe a few consequences of the Poisson formula.

Theorem 2.17. *For every continuous $g : \partial\mathbb{D} \rightarrow \mathbb{R}$ there exists exactly one continuous extension $f : \overline{\mathbb{D}} \rightarrow \mathbb{R}$ which is harmonic in \mathbb{D} with $f \upharpoonright_{\partial\mathbb{D}} = g$.*

This extension is called *Poisson extension*. This is an immediate consequence of the Poisson formula (exercise).

Theorem 2.18. *Let Ω be open and $f : \Omega \rightarrow \mathbb{C}$ continuous. Then f is harmonic if and only if for all $\overline{D_\varepsilon(z)} \subset \Omega$ and all harmonic $g : D_\varepsilon(z) \rightarrow \mathbb{R}$, the function $f \upharpoonright_{D_\varepsilon(z)} - g$ satisfies the maximum/minimum principle (i.e. if a maximum/minimum is attained, then it is constant on $D_\varepsilon(z)$).*

Proof. The 'only if' part is clear. For the other direction let g be the Poisson extension of $f \upharpoonright_{\partial D_\varepsilon(z)}$ on $D_\varepsilon(z)$. Then $f \upharpoonright_{D_\varepsilon(z)} - g$ satisfies the maximum/minimum principle. Since the function vanishes on the boundary $\partial D_\varepsilon(z)$ it must therefore vanish identically. \square

Theorem 2.19. *Let $f : \Omega \rightarrow \mathbb{R}$ be continuous such that for all $\overline{D_\varepsilon(z)} \subset \Omega$ the mean value property holds:*

$$f(z) = \frac{1}{2\pi} \int_0^{2\pi} f(z + \varepsilon e^{i\varphi}) d\varphi.$$

Then f is harmonic.

The proof is left as an exercise.

◇————— End of lecture 13. June 6, 2016 —————◇